

Semi-group Conditions for Affine Algebraic Plane Curves with More than One Place at Infinity

Penelope G. WIGHTWICK

Department of Mathematics and Statistics
University of Melbourne
Victoria 3010 — Australia
P.Wightwick@ms.unimelb.edu.au

Received: July 7, 2005
Accepted: September 28, 2006

ABSTRACT

An interesting and open question is the classification of affine algebraic plane curves. Abhyankar and Moh [1] completely described the possible links at infinity for those curves where the link has just one component, a knot. Such curves are said to have *one place at infinity*. The Abhyankar-Moh result has been of great assistance in classifying those polynomials which define a connected curve with one place at infinity. This paper provides a new proof of the Abhyankar-Moh result which is then used to find a description for the case where the polynomial defines a curve with *one point at infinity*.

Key words: affine algebraic curves, classification, link at infinity.

2000 Mathematics Subject Classification: 14R05 (14H20).

1. Introduction

An important topological feature of curves defined by polynomials is *the link at infinity*. For a polynomial $f \in \mathbb{C}[x, y]$ the link at infinity is the intersection of the associated curve C , defined by $f(x, y) = 0$, with a three dimensional sphere in \mathbb{C}^2 of radius large enough that all isolated singularities of C lie within the sphere. The link at infinity is invariant under automorphisms of \mathbb{C}^2 and is an important tool for

This research was supported by an Australian Postgraduate Award.

studying the topology of such curves. Consider the fibres, $\{f^{-1}(c) : c \in \mathbb{C}\}$, of a polynomial $f \in \mathbb{C}[x, y]$. A fibre $f^{-1}(c)$ is *regular* if for some neighbourhood D of $c \in \mathbb{C}$, $f|_{f^{-1}(D)}: f^{-1}(D) \rightarrow D$ is a locally trivial C^∞ fibration. Thus $f^{-1}(c)$ looks like nearby fibres and has no isolated singularities. The link at infinity of a regular plane curve C determines the topology of $C \subset \mathbb{C}^2$ as an embedded smooth 2-manifold up to ambient isotopy (see [18]). If C is not regular, the link at infinity, together with the Milnor numbers of any singularities in C , gives the Euler characteristic of C . Thus knowledge of the link at infinity of regular algebraic plane curves helps one to classify those with a given topology.

The question of classification of polynomials up to equivalence under automorphisms of \mathbb{C}^2 for certain specific cases has been addressed by a number of mathematicians. Perhaps the most well-known case is the Abhyankar-Moh-Suzuki theorem [1, 28] which says that, if $f \in \mathbb{C}[x, y]$ defines a curve $f(x, y) = 0$ that is smooth, connected and contractible, then f is equivalent to $g(x, y) = x$. This theorem has been proved by a number of people. As well as proving the theorem in a new way, Artal Bartolo [6] gives a history of proofs of this result.

Various people have looked at the classification of those polynomials which define a curve which is connected with one puncture, that is, where the link at infinity is a knot. Such polynomials are said to have *one place at infinity*. Neumann [18] has given a classification up to equivalence of irreducible polynomials whose curves are smooth, once punctured, connected and of genus less than or equal to 4. Miyanishi [16] describes simple forms to which once punctured, irreducible, smooth affine curves of genera 1, 2, 3, 4 are equivalent. A'Campo and Oka [5] have classified smooth curves of genus 1 or 2 with one place at infinity. Nakazawa and Oka [17] classify smooth, algebraic plane curves with one place at infinity of given genus ≤ 16 and have written down all possible normal forms of equations. There has been some duplication of cases classified, however the techniques used have varied from researcher to researcher.

Another related result is that of Zaidenberg and Lin [33] who have classified curves which are contractible and singular.

Progress in classification has also been made for polynomials for which every fibre is smooth and connected but not contractible. Artal Bartolo, Cassou-Noguès, and Velasco [8] have looked at families of smooth polynomial mappings of degree $6n + 4$ with fibres that are irreducible and generically of genus n . Cassou-Noguès [11] has used rational maps to find other families of polynomials with fibres that are smooth and irreducible.

A beautiful result of Abhyankar and Moh ([1]) completely described the possible links at infinity for those curves with one place at infinity. This result has been of great assistance in classifying those polynomials which define a connected curve with one place at infinity.

Given the importance of the Abhyankar–Moh result it is natural to ask

Can we find descriptions of the links at infinity for affine algebraic plane curves which have more than one place at infinity?

This question is addressed in sections 3 and 4 and descriptions are found for two cases, in particular for the case of one point at infinity and many places at infinity.

To describe links at infinity of affine algebraic plane curves we use the *splice diagrams* developed by Eisenbud and Neumann in [12]. These are a particularly useful way of encoding the details of certain links. Briefly the splice diagram is a finite tree with certain numerical and other decorations on it. These splice diagrams are particularly useful in the analysis of the links of affine algebraic plane curves. In section 2 we give a description of the splice diagram as it applies to the link at infinity of an algebraic curve and how to find it. This was first described by Neumann in [18] and also by Cassou-Noguès in [10] and Wightwick in [31]. We refer the reader to [18] and [10] for a full discussion of the properties of splice diagrams and the invariants which arise from these.

The splice diagram encoding the information for the link at infinity for a curve with one place at infinity is

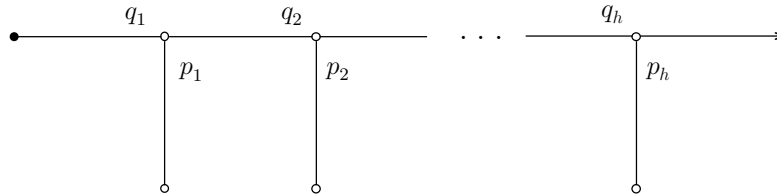

with $\gcd(p_k, q_k) = 1$, $p_k, q_k > 0$, for $k = 1, 2, \dots, h$. The conditions, called the *Abhyankar-Moh semi-group conditions*, are defined as follows. Let

$$\text{semi-group}\{\delta_0, \delta_1, \dots, \delta_{j-1}\}$$

be the set of all non-zero linear combinations of $\delta_0, \delta_1, \dots, \delta_{j-1}$ with non-negative integer coefficients.

Theorem 1.1 ([1]). *Let $f \in \mathbb{C}[x, y]$ be an irreducible polynomial that defines a curve $f(x, y) = 0$ with one place at infinity with the above splice diagram. Then for $j = 1, 2, 3, \dots, h$,*

$$q_j p_j p_{j+1} \cdots p_h \in \text{semi-group}\{p_1 p_2 \cdots p_h, q_1 p_2 p_3 \cdots p_h, q_2 p_3 p_4 \cdots p_h, \dots, q_{j-1} p_j \cdots p_h\}.$$

Sathaye ([24]) and Sathaye and Stenerson ([25]) show that any set of the linking numbers as defined above, $\{p_1, q_1, p_2, q_2, \dots, p_h, q_h\}$, satisfying the Abhyankar-Moh semi-group conditions is realisable as a semi-group associated with an algebraic curve.

In section 3 a new elementary proof for the Abhyankar–Moh result is provided. This uses the Newton polygons that are used in finding the Newton-Puiseux expansion of the polynomial. The Newton-Puiseux expansion refers to finding the roots of a

polynomial, $f(x, y)$ in the form $y - a(x)$ where a is a fractional power series in $x^{1/n}$ for some positive integer n (or similarly in the form $x - a(y)$). The advantage of the new proof is that it can easily be extended to find semi-group conditions which hold in other special cases.

The Newton polygons used in this paper are based on those used in [31] and differ from those described in [18] and [10]. As the form of the Newton polygons used to find the Newton-Puiseux expansion of a polynomial is a key element of the proof of the Abhyankar-Moh result, we give, in section 2, a detailed description of the procedure that is used.

In the original proof of Theorem 1.1 Abhyankar and Moh used the theory of valuations. Suzuki ([28]) has given an alternative proof of this result using the theory of resolutions. His proof gives some valuable insight into the geometry of an algebraic curve with one place at infinity. Another readable proof was given by Pinkham ([22]).

In section 4, I generalize the semi-group conditions from the case of one place at infinity to the important case of polynomials which define curves which have *one point at infinity*. The semi-group conditions arise quite naturally from the shapes of the splice diagrams (see sections 3 and 4).

Assuming that we have $f \in \mathbb{C}[x, y]$ irreducible with one point at infinity occurring at $y = 0$, then f will be monic in y but may have more than one component in the link at infinity. In this case there will be a maximal h such that the splice diagram of f contains the following section:

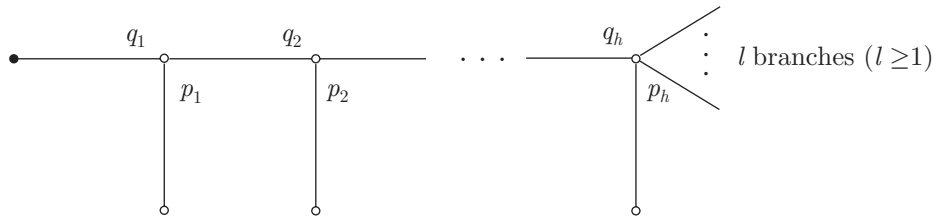

and such that $\deg_x(f) < \deg_y(f) = p_1 p_2 \cdots p_h d$ for some positive integer d .

Theorem 1.2. *Let $f \in \mathbb{C}[x, y]$ be an irreducible polynomial that defines a curve $f(x, y) = 0$ with one point at infinity with its splice diagram containing the section pictured above.*

Then for $j = 1, 2, \dots, h - 1$,

$$q_j p_j \cdots p_h d \in \text{semi-group}\{p_1 p_2 \cdots p_h d, q_1 p_2 p_3 \cdots p_h d, q_2 p_3 p_4 \cdots p_h d, \dots, q_{j-1} p_j \cdots p_h d\}.$$

Furthermore, there exists $r \in \mathbb{Z}$ with $1 \leq r \leq l$ such that

$$r q_h d \in \text{semi-group}\{p_1 p_2 \cdots p_h d, q_1 p_2 p_3 \cdots p_h d, q_2 p_3 p_4 \cdots p_h d, \dots, q_{h-1} p_h d\}.$$

Here the Abhyankar-Moh semi-group conditions are the case $d = 1$.

Note that the knots that are components of links at infinity are classified — they are simply the knots whose Puiseux pairs satisfy the reverse Puiseux inequalities (see [18]). Thus any additional restriction on Puiseux pairs of a branch must depend on how different branches are positioned with respect to each other. Moreover, examples show that one really only expects to be able to get a reasonable condition on an individual branch up to the point where branches diverge; weights no longer even have to be positive, in fact it is not hard to make them arbitrarily negative beyond this point.

The proof of Theorem 1.2 also gives some restrictions on the case with two points at infinity, but these are rather more technical (see section 5).

Ultimately one would like to understand what splice diagrams may be realised as affine algebraic plane curves and to understand the moduli spaces of the families of polynomials which give rise to these. The results and methods in this paper may help to achieve this objective.

2. Iterated torus links and the splice diagram

In this section we describe the splice diagrams of links at infinity of affine algebraic plane curves, and how to use the method of Newton polygons to find these. Some parts of this section have been discussed in [20].

2.1. The splice diagram

The link at infinity of an algebraic plane curve is a cabled torus link in S^3 and can be conveniently represented by the *splice diagram*. The splice diagram is a tree with various decorations. We briefly describe splice diagrams below. See Neumann [18], and Cassou-Noguès [10] for further details. For example, if the link at infinity is a knot it has a splice diagram of the form

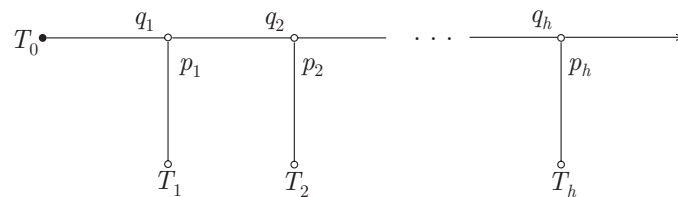

This splice diagram encodes the information that we:

- Start with an unknot.
- Cable a (p_1, q_1) torus knot on the unknot.
- Cable a (p_2, q_2) torus knot on the (p_1, q_1) torus knot.
- \vdots
- Cable a (p_h, q_h) torus knot on the (p_{h-1}, q_{h-1}) torus knot.

The final (p_h, q_h) cable is the link at infinity. The earlier “virtual” components used in constructing the link are represented by the vertices, T_1, \dots, T_h (those with just one edge adjoining them), the unknot being represented by the node T_1 and the (p_k, q_k) cable being represented by T_{k+1} . The nodes T_0 and T_1 form a virtual Hopf link. Note that

- T_0 is called the “root node” and is indicated by a solid disk rather than a circle.
- The *valency* of a vertex is the number of edges adjoining it.
- Vertices of valency 1 other than the root node are called *leaves*.
- Vertices of valency 2 or more are called *nodes*.
- Arrowheads represent actual components of the link at infinity.
- The weights attached to the diagram are oriented with respect to the root node, the weight closest to the root node on an edge is called the *near* weight and the one furthest away (if it exists) is called a *far* weight. Edge weights of 1 are usually omitted from the splice diagram.
- We can associate a numeric weight with each component of a link. Such a link, together with the numeric weights is called a *multilink*. The numeric weights are included in splice diagrams at the end of the arrowheads corresponding to the components. Such weights occur quite naturally in algebraic links and reflect the multiplicity of factors of polynomials.

Let $f \in \mathbb{C}[x, y]$ be such that

$$f = f_N + f_{N-1} + \dots + f_1 + f_0$$

where each f_i is homogeneous of degree i . Then the points at infinity where the algebraic plane curve $f^{-1}(c)$ meet infinity are the solutions of

$$f_N(x, y) = 0.$$

If there is more than one point at infinity the link at infinity is constructed by cabling on a Hopf link with one component for each point at infinity. There may be nodes of valency greater than three. For example

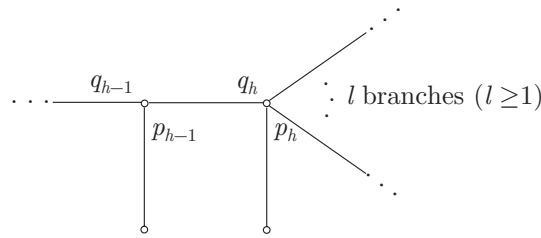

may arise in the construction of the link. In this case there are l parallel (p_h, q_h) torus knots cabled on the (p_{h-1}, q_{h-1}) cable.

If we take $c \in \mathbb{C}$ then an algebraic curve, $f^{-1}(c)$, is *regular* if for some neighbourhood of c , say D , $f|_{f^{-1}(D)}$ is a locally trivial fibration. For all but finitely many values of c , $f^{-1}(c)$ is regular.

A *minimal Seifert surface*, F say, is a Seifert surface with maximum Euler characteristic among all oriented embedded surfaces with no closed components in S^3 with $\partial F = \mathcal{L}$ where \mathcal{L} is a link. F may not be unique up to isotopy as a Seifert surface and the isotopy need not fix \mathcal{L} .

Theorem 2.1 ([18]). *The topology of a regular algebraic curve $V = f^{-1}(c) \subset \mathbb{C}^2$, as an embedded smooth manifold is determined up to ambient isotopy by its link \mathcal{L} at infinity. In fact a minimal Seifert surface F for \mathcal{L} in S^3 is unique up to isotopy in S^3 , and V can be recovered up to isotopy by attaching a collar out to infinity in \mathbb{C}^2 to the boundary of F .*

While we are able to recover a minimal Seifert surface with the same topology as a regular algebraic curve this is not the case for irregular curves. However we are at least able to find the Euler characteristic for this case.

Not all cable links arise as the link at infinity of an algebraic plane curve. The splice diagrams of links at infinity of algebraic plane curves can always be reduced to a unique *minimal* splice diagram satisfying the following conditions:

- (i) All near weights are positive.
- (ii) At most one near weight of a node differs from 1.

(iii) For the following edge in a splice diagram

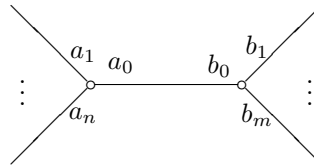

the *edge determinant* of the edge is

$$a_0 b_0 - a_1 \cdots a_n b_1 \cdots b_m.$$

All the edge determinants of a splice diagram for a link at infinity are negative.

A non-minimal splice diagram of a link at infinity can be simplified by the following moves:

- EN 1:** removing edges of weight 1 ending in a leaf or
- EN 2:** removing nodes of valency 2 (other than the root node).

We call a diagram which does not admit either of these moves *the minimal splice diagram of f*. If we allow deletion of the root vertex we obtain *the minimal unrooted splice diagram of f*.

We can use the above moves to reduce the number of edges in a splice diagram.

Theorem 2.2 ([12, 18]). *If Γ is a splice diagram which does not contain any edges of weight one ending in a leaf or nodes of valency 2 then Γ is minimal. Moreover Γ is unique in its equivalence class up to change of sign.*

Note that Theorem 2.2 implies that if we remove the root vertex from a splice diagram and obtain a minimal splice diagram satisfying its conditions then the resultant splice diagram is a combinatorial invariant of a given link at infinity of an algebraic plane curve under automorphisms of \mathbb{C}^2 . However the same is not true for the rooted splice diagram which includes additional information about the curve defined by a specific polynomial. For example, the root node encodes the number of points at infinity of the curve and the degree of the polynomial (see below).

2.2. The Newton-Puiseux expansion and the link at infinity

The Newton-Puiseux techniques for studying the singularities of affine algebraic plane curves have been long established (for example see [14, 21, 23]). It is only relatively recently that these methods have been extended to include the study of points at infinity (see Abhyankar and Moh [1], Neumann [18] and Cassou-Noguès [10]).

The idea is to find the *Puiseux expansion* for each component of the link at infinity. For example, if a component of a link at infinity corresponds to the curve meeting infinity at $y = 0$ we obtain an equation of the form

$$y = x^{q_1/p_1} (t_1 + x^{-\tau_2/(p_1 p_2)} (t_2 + x^{-\tau_3/(p_1 p_2 p_3)} + \dots))$$

with $q_1 < p_1$, $\gcd(p_1, q_1) = 1$, $p_i > 0$, $\tau_i > 0$, and $\gcd(p_i, \tau_i) = 1$ for all i . For some h , $p_j = 1$ for all $j > h$. We need only find the terms up to this point. This gives a branch of the splice diagram for $f = 0$ corresponding to one component of the link at infinity:

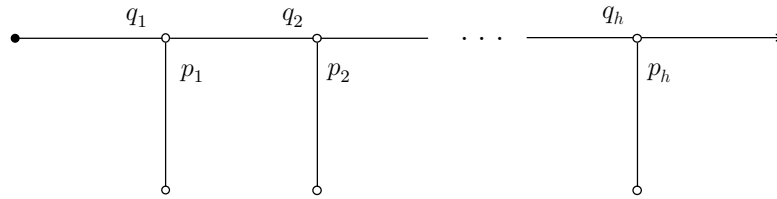

where $q_i = q_{i-1} p_{i-1} p_i - \tau_i$ for $i = 2, \dots, h$. In this context “branch of the splice diagram” means part of the finite tree in the natural way.

Definition 2.3. The pairs $(p_1, q_1), (p_2, -\tau_2), \dots, (p_h, -\tau_h)$ are called *Newton pairs*. The pairs $(p_1, q_1), (p_2, q_2), \dots, (p_h, q_h)$ are called *cabling pairs*.

Note that one or more of the p_i may be equal to 1. Replacing a link component by a $(1, q_i)$ cable does not change the topology of the link. We can find all the relevant equations and assemble the branches of the splice diagram by merging parts that correspond to identical initial Puiseux expansions.

In practice we use Newton polygons to find the Newton and cabling pairs and build up the splice diagram.

Definition 2.4. Let $f \in \mathbb{C}[x^{-1}, x, y]$ where

$$f = \sum a_{\alpha\beta} x^\alpha y^\beta$$

and consider the curve C defined by $f(x, y) = 0$. The Newton polygon of f is the convex hull of the points

$$\{(\alpha, \beta) \mid a_{\alpha\beta} \neq 0\}.$$

The Newton polygon of f is denoted $\text{NP}(f)$.

The process of using Newton polygons to find the splice diagram is as follows:

STEP 1: FIND THE STARTING HOPF LINK

$f = f_N + f_{N-1} + \dots + f_0$ where f_i is homogeneous of degree i . We find the solutions of $f_N = 0$, which will be of the form $x = a, y = b$ or $y = cx, a \neq 0$. We can always apply linear automorphisms of $\mathbb{C}[x, y]$ of the form $\phi(x, y) = (c_1x + d_1y, c_2x + d_2y)$ to ensure that the roots will be one of the following:

- (i) Where there is just one point at infinity: $y = 0$
- (ii) Where there are two point at infinity: $y = 0$ and $x = 0$
- (iii) Where there are more than 2, say $r + 2$, points at infinity: $y = 0, x = 0$ and $y = c_i x, i = 1, \dots, r$.

The initial splice diagram will consist of a root node and one arrowhead for each point at infinity. In two special cases we stop at this point.

- (i) If $f = (y-b)^N$, the Newton polygon includes the point $(0, N)$ which corresponds to one point at infinity. The link is the unknot with multiplicity N .



- (ii) If $f = (x - a)^m (y - b)^n$ with $m, n \geq 1$, the Newton polygon includes the point (m, n) , not on either axis, and the points at infinity are $x = 0$ and $y = 0$. The link is the Hopf link with two components with multiplicity m and n respectively.



There are two other special cases worthy of mention.

- (iii) If $f = \prod_{i=1}^m (y - a_i)^{n_i}, m > 1$ then there is one point at infinity and m components of the link at infinity. The solutions to $f(x, y) = 0$ are $y = a_i x^{0/1}$ with multiplicity n_i . We replace the one component Hopf link (the unknot) by m parallel $(0, 1)$ cables giving m parallel unknots.

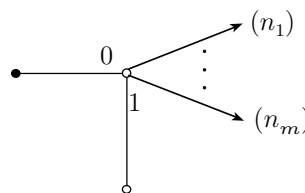

(iv) If $f = x^a y^b \prod_{i=1}^m (x^q y^p - c_i)^{n_i}$ then there are two points at infinity, $x = 0$ and $y = 0$. We can see that the fractional power series solutions are of the form

$$y = \sqrt[q]{c_i} x^{-q/p}$$

or

$$x = \sqrt[p]{c_i} x^{-p/q}$$

In addition we may have solutions $y = 0$ or $x = 0$ with multiplicity b and a respective. Thus we have cabling pairs (p, q) for the $y = 0$ point at infinity and (q, p) for the $x = 0$ point at infinity. We obtain the splice diagram

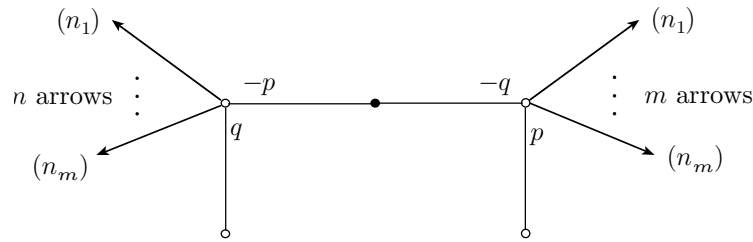

if $a = b = 0$; otherwise for $a > 0$ or $b > 0$ we retain the original component of the Hopf link with the relevant multiplicity a or b .

From now on we assume that we need to add one or more cables to the initial Hopf link. To analyse these cases we will need the following definition.

Definition 2.5. Let

$$f = \sum_{\alpha, \beta} a_{\alpha, \beta} x^\alpha y^\beta.$$

The (u, v) weighted degree of $a_{\alpha, \beta} x^\alpha y^\beta, a_{\alpha, \beta} \neq 0$ is $u\alpha + v\beta$. The maximum (u, v) weighted degree of f is

$$\max\{u\alpha + v\beta \mid a_{\alpha, \beta} \neq 0\}.$$

Express f in the form

$$f = \sum_{u\alpha + v\beta = d} a_{\alpha, \beta} x^\alpha y^\beta + \sum_{u\alpha + v\beta < d} a_{\alpha, \beta} x^\alpha y^\beta$$

where d is the maximum (u, v) weighted degree of f . Then the terms in

$$\sum_{u\alpha + v\beta = d} a_{\alpha, \beta} x^\alpha y^\beta$$

lie in the boundary of $\text{NP}(f)$. If there are two or more such terms then there is a line segment in $\partial \text{NP}(f)$ satisfying $u\alpha + v\beta = d$.

Definition 2.6. A single point in $\partial \text{NP}(f)$ satisfying $u\alpha + v\beta = d$ is called a *maximum (u, v) point of $\text{NP}(f)$* while a line segment consisting of all points satisfying $u\alpha + v\beta = d$ is called the *maximum (u, v) line segment of $\text{NP}(f)$* .

We then have the following:

- (i) The line segments corresponding to the point at infinity $y = 0$ are the maximum (p_i, q_i) line segments of $\text{NP}(f)$, $i = 1, \dots, m$ say, where $p_i, q_i \in \mathbb{Z}$, $p_i > 0$, $\text{gcd}(p_i, q_i) = 1$ and $p_i > q_i$. These line segments have slope $-p_i/q_i$, although one slope might be infinite. For convenience we think of this as slope $1/0$.
- (ii) The line segments corresponding to the point at infinity $x = 0$ are the maximum (q'_j, p'_j) line segments of $\text{NP}(f)$, $j = 1, \dots, k$ say, where $q'_j, p'_j \in \mathbb{Z}$, $p'_j > 0$, $\text{gcd}(p'_j, q'_j) = 1$ and $p'_j > q'_j$. These line segments have slope $-q'_j/p'_j$.
- (iii) The line segment in the Newton polygon which corresponds to points at infinity of the form $y = ax, a \neq 0$, if any, is the maximum $(1, 1)$ line segment of $\text{NP}(f)$, a line segment of slope -1 .

The following diagram shows the relevant line segments in $\partial \text{NP}(f)$ if there are three or more points at infinity:

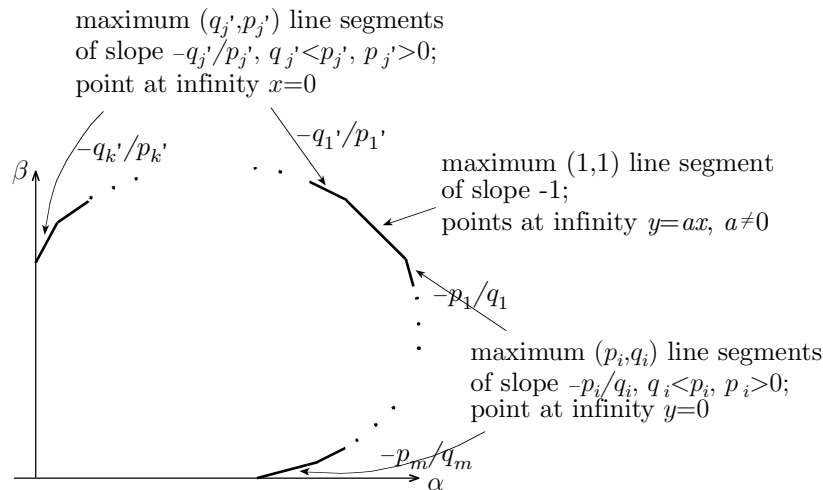

We will describe the procedure for finding further cabling pairs for the point at infinity $y = 0$. For the point at infinity, $x = 0$, one reverses the role of x and y in the initial substitution. For a point at infinity $y = ax$ we first use an affine automorphism of \mathbb{R}^2 , say $\phi : (x, y) \mapsto (c_1x + c_2y, d_1x + d_2y)$ to move the point at infinity to $y = 0$ and work with $\phi \circ f$ from Step 2.

STEP 2: ADDING THE FIRST CABLES

For each maximum (p_i, q_i) line segment of $\text{NP}(f)$ corresponding to the point at infinity $y = 0$ we consider the corresponding terms in f :

$$\sum_{p_i\alpha - q_i\beta = d_i} a_{\alpha\beta} x^\alpha y^\beta = c_i x^{a_i} y^{b_i} \prod_{j=1}^{s_i} (y^{p_i} - t_{ij}^{p_i} x^{q_i})^{l_{ij}}.$$

This gives s_i solutions

$$y = t_{ij} x^{q_i/p_i}$$

where $p_i > 0, q_i < p_i$ and a Newton pair (and cabling pair), (p_i, q_i) . Note that if two solutions differ by a root of unity they are equivalent. We have $q_1/p_1 > \dots > q_m/p_m$. We add each (p_i, q_i) cable to the $y = 0$ component of the Hopf link in turn. At the i^{th} operation we retain the Hopf link component unless it is the m^{th} operation in which case we only retain the original Hopf component if f has a factor $y^b, b \neq 0$. For the case where y^b is not a factor of f we obtain

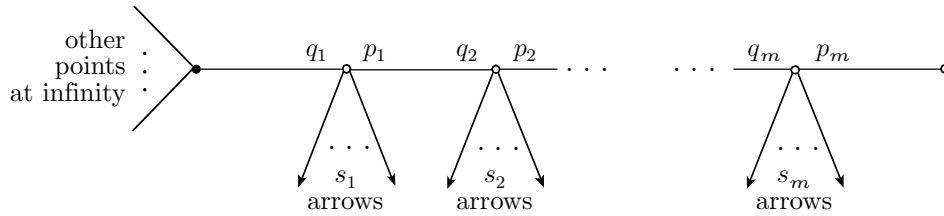

For the case where y^b is a factor of f we obtain

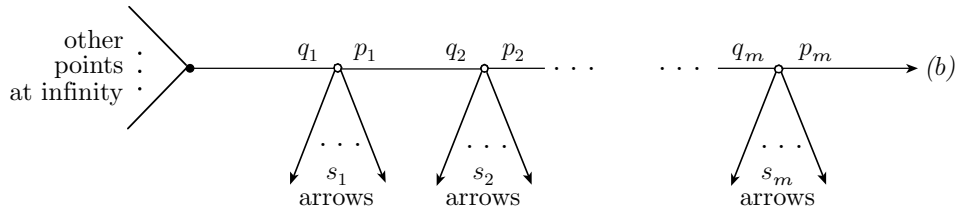

Thus we obtain s_i arrowheads for each maximum (p_i, q_i) line segment. If any $l_{ij} = 1$ no further cabling occurs on the relevant branch of the splice diagram and the corresponding arrowhead represents an actual component of the link at infinity. Otherwise we continue as in Step 3.

STEP 3: FURTHER CABLING

For each solution $y = t_{ij} x^{q_i/p_i}$ where $l_{ij} > 1$ we make the substitution

$$x = x_1^{p_i} \text{ and } y = x_1^{q_i} (y_1 + t_{ij})$$

to find $f_1(x_1, y_1) \in \mathbb{C}[x_1^{-1}, x_1, y_1]$. Draw $NP(f_1)$. Then the line segments corresponding to branches at infinity are the maximum $(p_{ij,k}, -\tau_{ij,k})$ line segments of $NP(f_1)$ where $p_{ij,k}, \tau_{ij,k} > 0$ and $p_{ij,k}, \tau_{ij,k} \in \mathbb{Z}$, $k = 1, \dots, m_{ij}$.

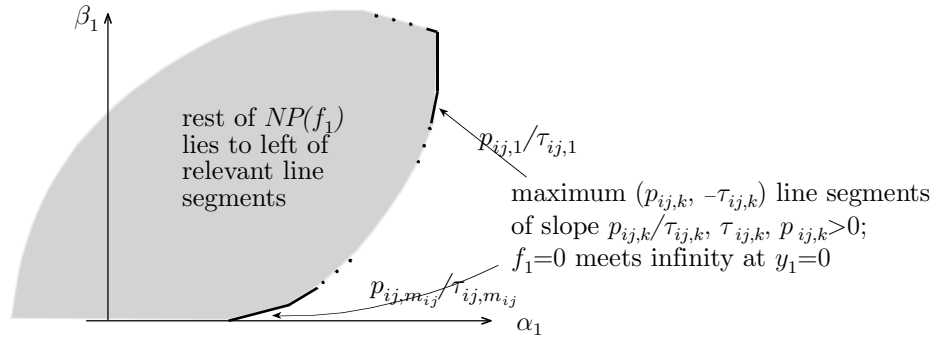

If there is just one line segment of height one so that the only Newton pair is $(p_{ij,1}, -\tau_{ij,1})$ with $p_{ij,k} = 1$ we stop cabling on the branch. Otherwise, we analyse each line segment as in Step 2. We obtain Newton pairs

$$(p_{ij,1}, -\tau_{ij,1}), \dots, (p_{ij,m_{ij}}, -\tau_{ij,m_{ij}})$$

giving cabling pairs

$$(p_{ij,1}, q_i p_i p_{ij,1} - \tau_{ij,1}), \dots, (p_{ij,m_{ij}}, q_i p_i p_{ij,m_{ij}} - \tau_{ij,m_{ij}}) \\ = (p_{ij,1}, q_{ij,1}), \dots, (p_{ij,m_{ij}}, q_{ij,m_{ij}})$$

and

$$q_{ij,1}/p_{ij,1} > \dots > q_{ij,m_{ij}}/p_{ij,m_{ij}}.$$

Cabling gives that the $(ij)^{\text{th}}$ arrowhead is replaced by the shaded region:

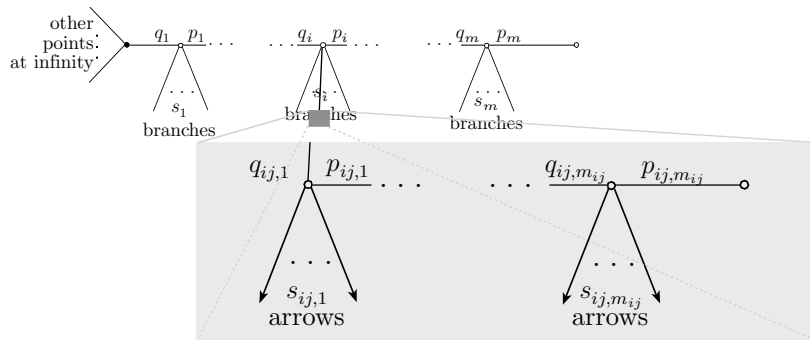

if f_1 does not have a factor $y_1^{b_{ij}}$ for some $b_{ij} \neq 0$, otherwise the original component is retained and we obtain

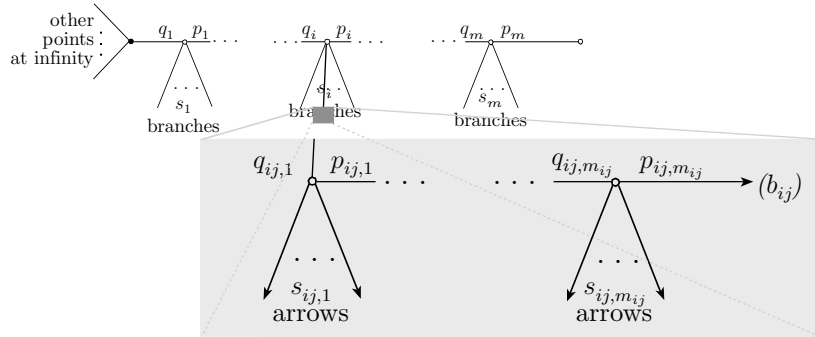

Let the maximum $(p_{ij,k}, -\tau_{ij,k})$ line segment have associated terms

$$d_k x_1^{a_k} y_1^{b_k} \prod_{r=1}^{s_{ij,k}} (y_1^{p_{ij,k}} - t_{k,r} x_1^{-\tau_{ij,k}})^{l_{k,r}}.$$

We add $s_{ij,k}(p_{ij,k}, q_{ij,k})$ cables to the k^{th} component. If any $l_{k,r} = 1$ no further cabling will be required on that branch and the arrowhead represents an actual component in the link at infinity for f . For $l_{k,r} \neq 1$ we make substitutions of the form

$$(x_1, y_1) = (x_2^{p_{ij,k}}, x_2^{-\tau_{ij,k}}(y_2 + t_{k,r})).$$

The first two terms of the Newton Puiseux expansion for the r^{th} solution corresponding to the k^{th} pair are now known:

$$y = t_{ij} x^{q_i/p_i} + t_{k,r} x^{q_i/p_i} x^{-\tau_{ij,k}/(p_i p_{ij,k})} + \dots$$

We continue in this fashion to find the Newton pairs. Apart from the initial cabling step, all the Newton polygons will be of the form found in Step 3.

Example 2.7 (The Briançon Polynomial).

$$f(x, y) = x^2(1 + xy)^4 + 3x(1 + xy)^3 + (3 - 8/3x)(1 + xy)^2 - 4(1 + xy) + y.$$

We will find the splice diagram for $f(x, y) = 0, \Gamma(f^{-1}(0))$. We first find the points at infinity by solving $x^2(xy)^4 = 0$ to get two points at infinity, $x = 0$ and $y = 0$. Thus our initial splice diagram is that of the two component Hopf link. Drawing the Newton polygon, $\text{NP}(f)$, we have

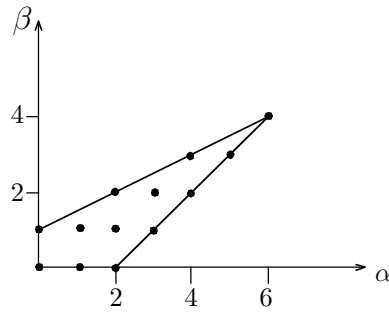

For $y = 0$ there is one line segment and the terms in f corresponding to this are

$$x^2(1 + xy)^4.$$

We solve $(1 + xy)^4 = 0$, obtaining $y = -x^{-1/1}$ as a solution. The Newton pair is $(1, -1)$ as is the cabling pair. As the exponent of $(1 + xy)^4$ is more than 1 we need to continue the algorithm. We substitute $(x, y) = (x_1^1, x_1^{-1}(y_1 - 1))$ to obtain

$$f_1 = x_1^2 y_1^4 + 3x_1 y_1^3 + 3y_1^2 - 8/3x_1 y_1^2 - 4y_1 + x_1^{-1} y_1 - x_1^{-1}$$

with Newton polygon

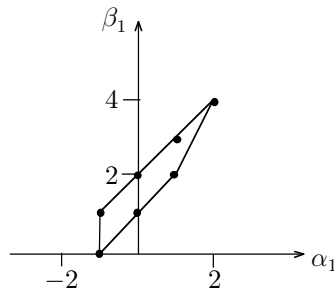

We have two line segments corresponding to branches at infinity. The first, of slope 2, has corresponding terms $f_{1,1} = x_1^2 y_1^4 - 8/3x_1 y_1^2 = x_1^2 y_1^2 (y_1^2 - 8/3x_1^{-1})$ giving a solution $y_1 = \sqrt[2]{8/3x_1^{-1/2}}$ as the required solution. The Newton pair is $(2, -1)$ and the cabling pair is $(2, -1 \times 1 \times 2 - 1) = (2, -3)$. As the exponent of $(y_1^2 - 8/3x_1^{-1})$ in $f_{1,1}$ is equal to one, we have completed this branch.

The other line segment of slope 1 has corresponding terms

$$f_{1,2} = -8/3x_1 y_1^2 - 4y_1 - x_1^{-1} = -8/3x_1 (y_1 + (3 + \sqrt{3})/4x_1^{-1})(y_1 + (3 - \sqrt{3})/4x_1^{-1})$$

with two relevant solutions of $f_{1,2} = 0$. The Newton pair is $(1, -1)$ and we add two $(1, -1 \times 1 \times 1 - 1) = (1, -2)$ parallel cables. As the exponents of $(y_1 + (3 + \sqrt{3})/4x_1^{-1})$ and $(y_1 + (3 - \sqrt{3})/4x_1^{-1})$ are both equal to 1 in $f_{1,2}$ we have completed this branch.

For $x = 0$ there is again one line segment with the corresponding terms being

$$y((x^2y)^3 + 3(x^2y)^2 + 3(x^2y) + 1) = y(x^2y + 1)^3$$

with solution $x = -y^{-1/2}$. Putting $(x, y) = (x_1^{-1}(y_1 - 1), x_1^2)$, we obtain f'_1 which has a Newton polygon with one relevant line segment giving Newton pair $(3, -1)$ and cabling pair $(3, -1 \times 2 \times 3 - 1) = (3, -7)$ at which stage we stop.

Thus we build up the splice diagrams as follows:

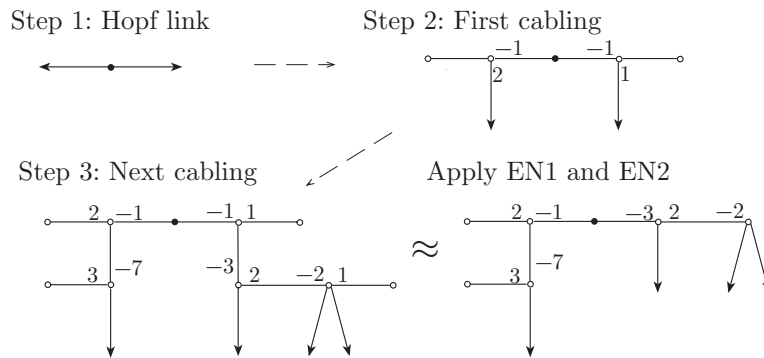

In step 3, one obtains two edges of weight 1 adjoining leaves. The reduced splice diagram was obtained by first deleting these leaves and edges and then deleting the resultant node of valency two.

2.3. Invariants from splice diagrams

Definition 2.8. Given a vertex, v , of a splice diagram, Γ , the *linking coefficient at v* , also called the *multiplicity at v* is the sum over the arrowheads, w , of Γ :

$$l_v = \sum_w l(v, w),$$

where $l(v, w)$ is the product of edge weights directly adjacent to, but not on, the path from v to w in Γ .

The splice diagram for the Briançon polynomial, $\Gamma(f^{-1}(0))$ (Example 2.7) has the linking coefficients indicated in brackets in the diagram below:

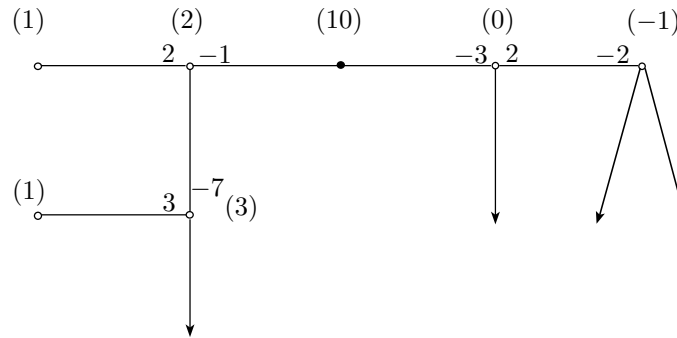

PROPERTIES OF THE LINKING COEFFICIENTS

The properties relating to the linking coefficients of splice diagrams of links at infinity are as follows:

- (i) The degree of a polynomial is always the linking coefficient l_\bullet at the root vertex.
- (ii) A splice diagram is regular, that is, the splice diagram of a regular fibre of f , if and only if it has no negative linking coefficients.
- (iii) A polynomial has fibres with irregular splice diagrams if and only if the regular splice diagram has at least one zero linking coefficient. Each irregular diagram determines the regular one and the regular one strongly constrains the number and form of the irregular ones. See Neumann ([19]), for details.
- (iv) The Euler characteristic of the generic fibre of f is

$$\chi_{\text{reg}} := \sum_{v \in \text{vert } \Gamma(f)} (2 - \sigma_v) l_v,$$

where $\text{vert } \Gamma(f)$ is the set of non-arrowhead vertices of $\Gamma(f)$ and σ_v is the valency of vertex v (number of edges at v).

- (v) For any $c \in \mathbb{C}$ define the Milnor number at infinity of $f^{-1}(c)$ as

$$\lambda_c := \sum_{\substack{v \in \Gamma(f^{-1}(c)) \\ l_v < 0}} (2 - \sigma_v) l_v$$

so $\lambda_c = 0$ unless $\Gamma(f^{-1}(c))$ is irregular. Moreover, if $f^{-1}(c)$ is a reduced fibre (that is, one without multiple components), the *total Milnor number* is the sum of Milnor numbers (see Milnor [15])

$$\mu_c := \sum_{p \in f^{-1}(c)} \mu_p.$$

As $\mu_p = 0$ at non-singular points, this is a finite sum. Then the Euler characteristic of a reduced fibre $f^{-1}(c)$ is given by

$$\chi(f^{-1}(c)) = \mu_c + \sum_{v \in \text{vert } \Gamma(f^{-1}(c))} (2 - \sigma_v) l_v = \mu_c + \lambda_c + \chi_{\text{reg}}.$$

(vi) Suzuki ([27]) showed that for any f one has

$$1 - \chi_{\text{reg}} = \mu_c + \sum_{c \in \mathbb{C}} (\chi(f^{-1}(c)) - \chi_{\text{reg}})$$

so, if f has only isolated singularities,

$$1 - \chi_{\text{reg}} = \sum_{c \in \mathbb{C}} (\mu_c + \lambda_c).$$

One consequence of this formula is that, once we have found finite singularities and singularities at infinity contributing enough μ_c and λ_c to satisfy the formula, we know that we have found all non-generic fibres.

Example 2.9 (The Briancon Polynomial continued). We have found the splice diagram $\Gamma(f^{-1}(0))$ for this polynomial. There are two other splice diagrams for links at infinity. For the regular fibres $f^{-1}(t)$, $t \neq 0, -16/9$ we find that $\Gamma(f^{-1}(t))$ is

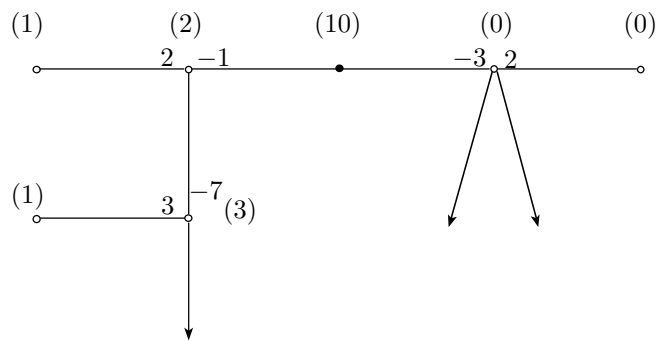

while for the other fibre $f^{-1}(-16/9)$, $\Gamma(f^{-1}(-16/9))$ is

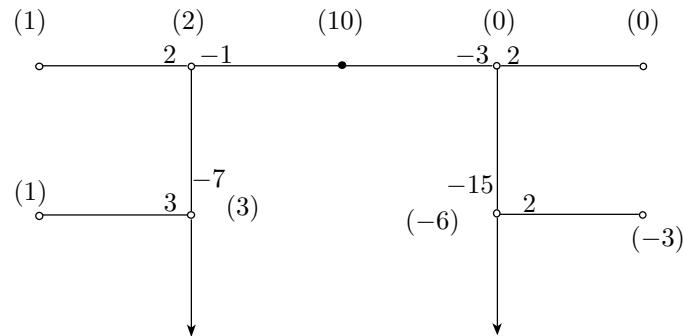

From these diagrams we find

$$\chi_{\text{reg}} = 1(2 - 1) + 3(2 - 3) + 1(2 - 1) + 2(2 - 3) + 10(2 - 2) + 0(2 - 3) = -3,$$

$$\lambda_0 = (-1)(2 - 3) = 1,$$

and

$$\lambda_{-16/9} = 3.$$

We thus obtain

$$\chi_{\text{reg}} + \lambda_0 + \lambda_{-16/9} = -3 + 1 + 3 = 1$$

so that $\mu_c = 0$ for all c . It follows that the Briançon polynomial has no finite singularities.

3. The semi-group condition for curves with one place at infinity

This section gives the new proof of Theorem 1.1. We start by restating the theorem. Let $f \in \mathbb{C}[x, y]$ be an irreducible polynomial that defines a curve $f(x, y) = 0$ with one place at infinity, thus having a link at infinity whose minimal splice diagram is as follows:

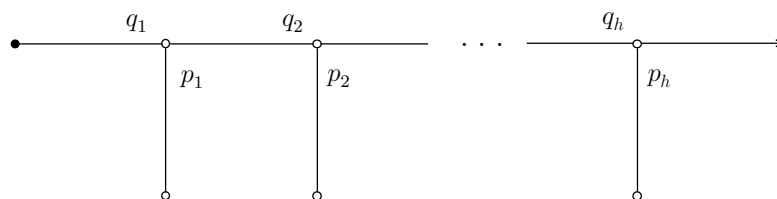

Name the vertices of the splice diagram as follows. Starting from the root vertex and moving towards the arrowhead:

- vertices with one adjoining edge are u_0, u_1, \dots, u_h
- vertices with three adjoining edges are v_1, v_2, \dots, v_h

Let L denote the link at infinity and let S_w denote the virtual component of the link corresponding to the node w for $w \in \{u_i : i = 1, \dots, h\} \cup \{v_j : 1, \dots, h\}$. Then the linking numbers of the virtual components with the link at infinity are named as follows:

$$\begin{aligned} \delta_0 = l_{u_0} &= \text{link}(S_{u_0}, L) = p_1 p_2 \cdots p_h, \\ \delta_1 = l_{u_1} &= \text{link}(S_{u_1}, L) = q_1 p_2 p_3 \cdots p_h, \\ \delta_2 = l_{u_2} &= \text{link}(S_{u_2}, L) = q_2 p_3 p_4 \cdots p_h, \\ &\vdots \\ \delta_h = l_{u_h} &= \text{link}(S_{u_h}, L) = q_h, \\ \psi_1 = l_{v_1} &= \text{link}(S_{v_1}, L) = q_1 p_1 p_2 \cdots p_h, \\ \psi_2 = l_{v_2} &= \text{link}(S_{v_2}, L) = q_2 p_2 p_3 \cdots p_h, \\ &\vdots \\ \psi_h = l_{v_h} &= \text{link}(S_{v_h}, L) = q_h p_h. \end{aligned}$$

We now restate Theorem 1.1 in terms of these linking numbers.

Theorem 1.1 (The Abhyankar-Moh Semi-Group Theorem restated). *Let $f \in \mathbb{C}[x, y]$ be an irreducible polynomial that defines a curve $f(x, y) = 0$ with one place at infinity. Then using the above notation we have:*

For $j = 1, 2, 3, \dots, h$,

$$\psi_j \in \text{semi-group}\{\delta_0, \delta_1, \dots, \delta_{j-1}\}$$

where semi-group $\{\delta_0, \delta_1, \dots, \delta_{j-1}\}$ is the set of all non-zero linear combinations of $\delta_0, \delta_1, \dots, \delta_{j-1}$ with non-negative integer coefficients.

This theorem limits the possible values of q_j , in terms of p_1, \dots, p_{j-1} and q_1, \dots, q_{j-1} .

3.1. The essence of the proof

The proof of the Theorem 1.1 depends on some rather technical lemmas so, before giving all the details, we describe the main ideas and show how these combine to give the result. In the case of $f = y + c$, Theorem 1.1 is trivially true. We prove the theorem under the assumption that the cabling pairs found are $\{(p_1, q_1), (p_2, q_2), \dots, (p_h, q_h)\}$ with $p_i > 1, i = 1, \dots, h$. The case of redundant cabling pairs of the type $(1, s)$ is addressed in section 3.6 and the proof follows the same lines as the case without redundant pairs.

There are three main steps in the proof.

- (i) We express the polynomial f as the sum of other polynomials using “approximate roots of polynomials” (see below).
- (ii) We then analyse the Newton polygon used to find the cabling pair (p_k, q_k) by finding the contribution of each summand to the Newton polygon.
- (iii) Finally we show that the actual proof follows fairly easily from this analysis.

STEP 1: APPROXIMATE ROOTS OF POLYNOMIALS (SECTION 3.2)

Abhyankar and Moh [3] developed the concept of approximate roots of polynomials. Their main result is the following lemma (Lemma 3.7).

Let $f \in \mathbb{C}[x, y]$ be monic in y with $\deg_y(f) = kl$, $k, l \in \mathbb{Z}$, $k, l > 1$. Then there exists a unique $g \in \mathbb{C}[x, y]$ such that g is monic in y , $\deg_y(g) = k$ and

$$f(x, y) = g^l + \zeta$$

where $\deg_y(\zeta) < (l - 1)k = (l - 1)\deg_y(g)$.

Definition 3.1. The polynomial g is the l^{th} approximate root of f .

The main result used in the proof of Theorem 1.1 is Lemma 3.9 (Suzuki [28]). Let $f \in \mathbb{C}[x, y]$ be monic in y and $\deg_y(f) = p_1 p_2 \cdots p_k \cdots p_h$. Then f can be written as

$$f = g_k^{p_k \cdots p_h} + \zeta_k$$

where g_k is the $(p_k \cdots p_h)^{\text{th}}$ approximate root of f . Moreover

$$\zeta_k = \sum_{\gamma_0, \dots, \gamma_k} a_{\gamma_0 \dots \gamma_k} g_0^{\gamma_0} g_1^{\gamma_1} \cdots g_k^{\gamma_k}$$

where $g_0 = x$ and g_1, g_2, \dots, g_{k-1} are the $(p_1 p_2 \cdots p_h)^{\text{th}}$, $(p_2 \cdots p_h)^{\text{th}}$, \dots , $(p_{k-1} \cdots p_h)^{\text{th}}$ approximate roots of f respectively. In addition, $0 \leq \gamma_0$, $0 \leq \gamma_1 < p_1$, \dots , $0 \leq \gamma_{k-1} < p_{k-1}$, $0 \leq \gamma_k < p_k \cdots p_h - 1$.

We use the approximate roots where p_1, p_2, \dots, p_h are given in the splice diagram of f .

STEP 2: THE NEWTON POLYGONS OF f, g_0, \dots, g_h (SECTIONS 3.3 AND 3.5)

We match features in the “ k^{th} ” Newton polygon of f , $\text{NP}_k(f)$ say, used to find the pair (p_k, q_k) with the k^{th} Newton polygons of the components of ζ_k , $a_{\gamma_0 \dots \gamma_k} g_0^{\gamma_0} g_1^{\gamma_1} \cdots g_k^{\gamma_k}$. Before doing so we give a few definitions.

Definition 3.2. The line segments in the boundary of a Newton polygon which correspond to the points at infinity of a curve C defined by $f(x, y) = 0$ where $f \in \mathbb{C}[x, y]$ are described in section 2. These line segments will be called the *key line segments* of the Newton polygon.

Definition 3.3. If

$$f(x, y) = \sum a_{\alpha\beta} x^\alpha y^\beta$$

then the points in the set

$$\{(\alpha, \beta) \mid a_{\alpha\beta} \neq 0\}$$

are called the *key points* of $\text{NP}(f)$, the Newton polygon of f .

We define the notion of corner point where there is one or no key line segments in a Newton polygon.

Definition 3.4. Let $\{(\alpha, \beta) \mid a_{\alpha\beta} \neq 0\}$ be the set of key points of $\text{NP}(f)$. Then the *corner point* of $\text{NP}(f)$ is the following key point:

- (i) where there is a key line segment, the point (α, β) in the key line segment such that β is maximum.
- (ii) where there is no key line segment, the point (α', β') such that $\alpha' = \max\{\alpha \mid a_{\alpha\beta} \neq 0\}$ and $\beta' = \min\{\beta \mid (\alpha', \beta) \mid a_{\alpha'\beta} \neq 0\}$.

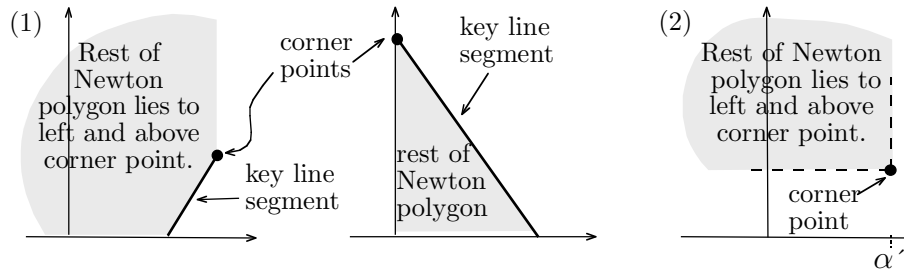

Some relevant facts about Newton polygons are proved in section 3.4.

We now turn to the Newton polygons of f . Without loss of generality we assume that C meets infinity at $y = 0$. Assume that in order to find the Newton pairs of f we make the substitutions:

$$\Phi_j : (x_j, y_j) = (x_{j+1}^{p_j}, x_{j+1}^{-r_j}(y_{j+1} + t_j))$$

for $j = 1, \dots, h - 1$, where $(x_1, y_1) = (x, y)$.

Definition 3.5. Let

$$f_j = f \circ \Phi_1 \circ \dots \circ \Phi_{j-1}$$

for $j = 2, \dots, h$. Denote the Newton polygons, $\text{NP}(f)$, $\text{NP}(f_2)$, \dots , $\text{NP}(f_h)$ by

$$\text{NP}_1(f), \text{NP}_2(f), \dots, \text{NP}_h(f)$$

respectively. We call the set $\{\text{NP}_j(f)\}_{j=1}^h$ the *Newton polygons of f* .

Assume that we make the precisely the same substitutions $\{\Phi_j\}$ in some polynomial H .

Definition 3.6. Define

$$H_j = H \circ \Phi_1 \circ \dots \circ \Phi_{j-1}$$

for $j = 2, \dots, h$ and define the Newton polygons of H as

$$NP_1(H) = NP(H), NP_2(H) = NP(H_2), \dots, NP_h(H) = NP(H_h).$$

In Lemma 3.10 we establish that $NP_k(f)$ has just one key line segment as given in the following diagram:

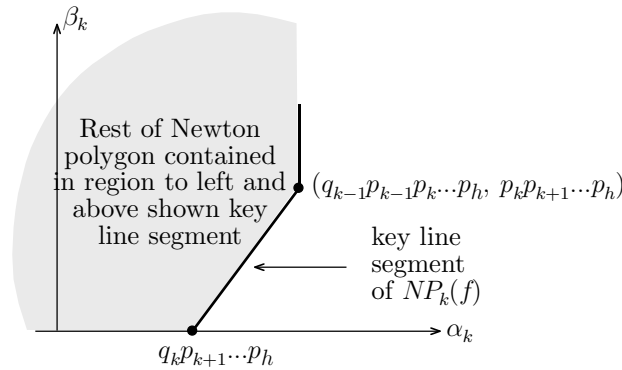

This key line segment shown on the diagram is the one used to find the Newton pair (p_k, q_k) in the splice diagram. The line segment has slope τ_k and we know that we must obtain just one Newton pair from this line segment. Thus the terms in $f(x_k, y_k)$ corresponding to this line segment must be of the form

$$c_k x_k^{q_k p_{k+1} \dots p_h} (y_k^{p_k} - t_k^{p_k} x_k^{-\tau_k})^{p_{k+1} \dots p_h}$$

and every integer point on the key line segment must be a key point of the Newton polygon.

In section 3.5 we use induction to establish the following results about the Newton polygons of the components of $f, g_k^{p_k \dots p_h}$ and $a_{\gamma_0 \dots \gamma_k} g_0^{\gamma_0} \dots g_k^{\gamma_k}$.

(i) Neither

$$NP_k(g_k^{p_k \dots p_h})$$

nor any

$$NP_k(a_{\gamma_0 \dots \gamma_k} g_0^{\gamma_0} g_1^{\gamma_1} \dots g_k^{\gamma_k})$$

where $a_{\gamma_0 \dots \gamma_k} g_0^{\gamma_0} g_1^{\gamma_1} \dots g_k^{\gamma_k} \neq 0$ has a key line segment parallel to that of $NP_k(f)$ (Lemmas 3.15 and 3.24).

(ii) The corner point of $NP_k(a_{\gamma_0 \dots \gamma_k} g_0^{\gamma_0} \dots g_k^{\gamma_k})$ is at

$$\alpha_k = p_1 \dots p_{k-1} \gamma_0 + q_1 p_2 \dots p_{k-1} \gamma_1 + \dots + q_{k-1} \gamma_{k-1} + q_{k-1} p_{k-1} \gamma_k$$

$$\beta_k = \gamma_k$$

(Corollary 3.20 to Lemma 3.19).

(iii) The Newton polygons, $NP_k(g_k^{p_k \dots p_h})$ and $NP_k(a_{\gamma_0 \dots \gamma_k} g_0^{\gamma_0} \dots g_k^{\gamma_k})$, have no point lying to the right of $NP(f)$ and thus their corner points do not lie to the right of $NP_k(f)$ (Lemmas 3.15 and 3.25). No two of these corner points coincide (Lemma 3.23).

(iv) For each key point on the key line segment of $NP_k(f)$, that is, (α_k, β_k) where

$$\alpha_k = q_{k-1} p_{k-1} p_k \dots p_h - s \tau_k,$$

$$\beta_k = p_k \dots p_h - s p_k$$

for $s = 1, \dots, (p_k \dots p_h)$, there exists a term in ζ_k ,

$$a_{\gamma_0 \dots \gamma_k} g_0^{\gamma_0} \dots g_k^{\gamma_k}$$

such that the corner point of $NP_k(a_{\gamma_0 \dots \gamma_k} g_0^{\gamma_0} \dots g_k^{\gamma_k})$ is this key point (Lemma 3.26).

(v) For $i = 1, \dots, k$, $NP_i(g_{k+1})$ has the same key line segment as $NP_i(f)$ and the terms in $g_{k+1,i}$ and f_i corresponding to this key line segment are the same. This implies that the first k Newton pairs, and hence cabling pairs, of f_i and $g_{k+1,i}$ are identical (Lemmas 3.17 and 3.29).

Diagrammatically the above can be illustrated as follows:

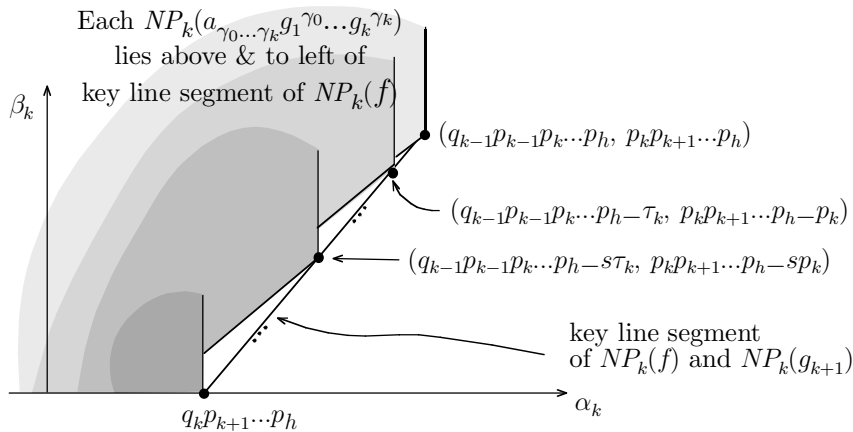

STEP 3: PROOF OF THEOREM 1.1

Proof of Theorem 1.1. The result is clear for $k = 1$ as

$$\psi_1 = q_1 p_1 \cdots p_h, \quad q_1 > 1 \quad \text{and} \quad \delta_0 = p_1 \cdots p_h$$

so that

$$\psi_1 \in \text{semi-group}\{\delta_0\}.$$

Now consider q_k . As described in step 2, result (ii), there is some term in f ,

$$a_{\gamma'_0 \dots \gamma'_k} g_0^{\gamma'_0} \cdots g_k^{\gamma'_k},$$

say, with $a_{\gamma'_0 \dots \gamma'_k} \neq 0$ whose Newton polygon $\text{NP}_k(a_{\gamma'_0 \dots \gamma'_k} g_0^{\gamma'_0} g_1^{\gamma'_1} \cdots g_k^{\gamma'_k})$ has corner point at the key point, $(q_{k-1} p_{k-1} p_k \cdots p_h - \tau_k, p_k \cdots p_h - p_k)$ on $\text{NP}_k(f)$. Thus

$$\gamma'_k = p_k \cdots p_h - p_k$$

and

$$\begin{aligned} p_1 \cdots p_{k-1} \gamma'_0 + q_1 p_2 \cdots p_{k-1} \gamma'_1 + \cdots + q_{k-1} \gamma'_{k-1} + q_{k-1} p_{k-1} \gamma'_k \\ = q_{k-1} p_{k-1} p_k \cdots p_h - \tau_k. \end{aligned}$$

Therefore

$$\begin{aligned} p_1 \cdots p_{k-1} \gamma'_0 + q_1 p_2 \cdots p_{k-1} \gamma'_1 + \cdots + q_{k-1} \gamma'_{k-1} + q_{k-1} p_{k-1} (p_k \cdots p_h - p_k) \\ = q_{k-1} p_{k-1} p_k \cdots p_h - \tau_k \end{aligned}$$

and, as $q_k = q_{k-1} p_{k-1} p_k - \tau_k$ (from section 2.2),

$$p_1 \cdots p_{k-1} \gamma'_0 + q_1 p_2 \cdots p_{k-1} \gamma'_1 + \cdots + q_{k-1} \gamma'_{k-1} = q_{k-1} p_{k-1} p_k - \tau_k = q_k.$$

Multiply each side by $p_k \cdots p_h$ to obtain

$$\delta_0 \gamma'_0 + \delta_1 \gamma'_1 + \cdots + \delta_{k-1} \gamma'_{k-1} = q_k p_k \cdots p_h = \psi_k.$$

As $\gamma'_i \geq 0$, for all i , and from Lemma 3.10, $q_k \neq 0$, the result follows and

$$\psi_k \in \text{semi-group}\{\delta_0, \dots, \delta_{k-1}\}. \quad \square$$

It remains to prove the details summarised above in steps 1 and 2.

3.2. Approximate roots of polynomials

We first need to understand the ideas behind the generalized Tschirnhausen transformation developed by Abhyankar and Moh ([3]). Let $f \in \mathbb{C}[y]$ be a monic polynomial of degree n :

$$f(y) = y^n + a_{n-1}y^{n-1} + a_{n-2}y^{n-2} + \dots + a_0.$$

One can use a substitution, replacing $y + \frac{a_{n-1}}{n}$ by y , to “kill off” the coefficient of y^{n-1} . This affine automorphism is a Tschirnhausen transformation ([29]). A useful way of looking at this is the following. Divide f by $(y + \frac{a_{n-1}}{n})^n$ and express f in the form

$$f(y) = \left(y + \frac{a_{n-1}}{n}\right)^n + r_1(y)$$

where $c_i \in \mathbb{C}$ and $\deg_y \psi \leq n - 2$. By dividing $r_1(y)$ by $(y + \frac{a_{n-1}}{n})^{n-2}$ we obtain

$$r_1(y) = c_{n-2} \left(y + \frac{a_{n-1}}{n}\right)^{n-2} + r_2(y)$$

with $\deg_y r_2 \leq n - 3$. We can continue in this fashion until we find

$$f(y) = \left(y + \frac{a_{n-1}}{n}\right)^n + \sum_{j=0}^{n-2} c_j \left(y + \frac{a_{n-1}}{n}\right)^j$$

for some $c_j \in \mathbb{C}$.

Abhyankar and Moh generalized this as follows to find the l^{th} approximate root of f :

Lemma 3.7. *Let $f \in \mathbb{C}[x, y]$ be monic in y with $\deg_y(f) = kl$, $k, l \in \mathbb{Z}$, $k, l > 1$. Then there exists a unique $g \in \mathbb{C}[x, y]$ such that g is monic in y , $\deg_y(g) = k$ and*

$$f(x, y) = g^l + \zeta$$

where $\deg_y(\zeta) < (l - 1)k = (l - 1) \deg_y(g)$.

The proof of Lemma 3.7 is in [3]. We will use this lemma to show the following:

Lemma 3.8. *Let*

- $f \in \mathbb{C}[x, y]$ be monic in y with $\deg_y(f) = klm$, $k, l, m \in \mathbb{Z}$, $k, l, m > 1$,
- h be the m^{th} approximate root of f and
- g be the l^{th} approximate root of h .

Then g is the lm^{th} approximate root of f .

Proof. As h is the m^{th} approximate root of f ,

$$f = h^m + \zeta$$

where $\deg_y(\zeta) < (m - 1)kl = (m - 1) \deg_y(h)$. As g is the l^{th} approximate root of h ,

$$h = g^l + \phi$$

where $\deg_y(\phi) < (l - 1)k = (l - 1) \deg_y(g)$. Thus

$$\begin{aligned} f &= h^m + \zeta \\ &= (g^l + \phi)^m + \zeta \\ &= g^{lm} + \sum_{i=1}^m \binom{m}{i} \phi^i g^{l(m-i)} + \zeta. \end{aligned}$$

Hence

$$\deg_y(f - g^{lm}) \leq \deg_y(\phi) + (m - 1) \deg_y(g^l) < kl - k + (m - 1)kl = (ml - 1) \deg_y(g).$$

By the uniqueness of approximate roots, g is the lm^{th} approximate root of f . \square

The main result we need for the proof of Theorem 1.1 is as follows:

Lemma 3.9. *Let $f \in \mathbb{C}[x, y]$ be monic in y and $\deg_y(f) = p_1 p_2 \cdots p_k \cdots p_h$. Let $g_0 = x$ and g_1, g_2, \dots, g_k be the $(p_1 p_2 \cdots p_h)^{\text{th}}$, $(p_2 \cdots p_h)^{\text{th}}$, \dots , $(p_k \cdots p_h)^{\text{th}}$ approximate roots of f respectively. Then we can express f as a sum of polynomials as follows. Given*

$$f = g_k^{p_k p_{k+1} \cdots p_h} + \zeta_k$$

then

$$\zeta_k = \sum_{\gamma_0, \dots, \gamma_k} a_{\gamma_0 \dots \gamma_k} g_0^{\gamma_0} g_1^{\gamma_1} \cdots g_k^{\gamma_k}$$

with $0 \leq \gamma_0, 0 \leq \gamma_1 < p_1, \dots, 0 \leq \gamma_{k-1} < p_{k-1}, 0 \leq \gamma_k < p_k p_{k+1} \cdots p_h - 1$.

The proof is given by Suzuki in [28].

3.3. The Newton polygons of f

We have assumed that the cabling pairs of f are either just $\{(1, 0)\}$ or, for some $h \geq 1$,

$$\{(p_1, q_1), (p_2, q_2), \dots, (p_h, q_h)\}$$

with $p_i > 1$ for all i . (The case where there are redundant cabling pairs of the form $(1, r)$ is addressed in section 3.6.)

The attributes of $\text{NP}_1(f)$ are as follows. If $f \in \mathbb{C}[x, y]$ is irreducible and $f(x, y) = 0$ defines a curve in \mathbb{C}^2 with one place at infinity, its Newton polygon, assuming that f has a non-zero constant term, is one of the following:

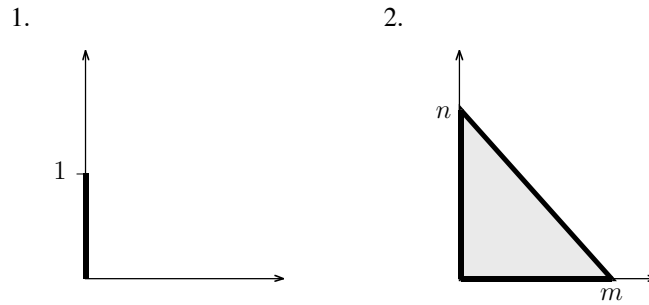

In case 1, $f(x, y) = y$, the curve is just a line and has splice diagram



Thus for case 1, Theorem 1.1 is trivially true. Case 2 is the interesting case and we discuss this in detail. As there is only one place at infinity we know that the key line segment of $NP_1(f)$ will give exactly one Newton pair. As we have assumed that the curve meets infinity at $y = 0$, $n > m$. From the splice diagram, we see that the root node has linking number $\delta_0 = p_1 p_2 \cdots p_h$. So the degree of the polynomial is also $n = p_1 p_2 \cdots p_h$ (see section 2). Thus we can assume, without loss of generality and by applying, where necessary, polynomial automorphisms of \mathbb{C}^2 as described in Neumann and Wightwick ([20]) and Wightwick ([32]) that

- $n > m$ so that $n = p_1 p_2 \cdots p_h$.
- $m > 1$.
- f is monic in y and

$$f(x, y) = y^n + \sum_{j=2}^n a_j y^{n-j}$$

where $a_j \in \mathbb{C}[x]$.

- f is monic in x . As the line segment in the boundary of the Newton polygon has slope $-p_1/q_1$, $m = \deg_x(f) = q_1 p_2 p_3 \cdots p_h$.
- $q_1 \neq 1$ and $p_2, \dots, p_h > 1$. If any of $p_2, p_3, \dots, p_h = 1$, the splice diagram would not be minimal.

Given the above degrees, the polynomial, f , is of the form

$$f(x, y) = \sum_{p_1\alpha + q_1\beta = q_1p_1p_2 \cdots p_h} a_{\alpha\beta}x^\alpha y^\beta + \sum_{p_1\alpha + q_1\beta < q_1p_1p_2 \cdots p_h} a_{\alpha\beta}x^\alpha y^\beta$$

or, alternatively,

$$f(x, y) = (y^{p_1} - t_1^{p_1}x^{q_1})^{p_2p_3 \cdots p_h} + \sum_{p_1\alpha + q_1\beta < q_1p_1p_2 \cdots p_h} a_{\alpha\beta}x^\alpha y^\beta$$

with $t_1^{p_1} = 1$.

Lemma 3.10. *At the k^{th} stage, $k = 2, 3, \dots, h$, of finding Newton pairs, the Newton polygon, $NP_k(f)$,*

(i) *has one key line segment with end points*

$$(q_k p_{k+1} \cdots p_h, 0) \quad \text{and} \quad (q_{k-1} p_{k-1} p_k p_{k+1} \cdots p_h, p_k p_{k+1} \cdots p_h),$$

(ii) *has key points at*

$$\alpha_k = q_k p_k \cdots p_h - s\tau_k \quad \text{and} \quad \beta_k = p_k \cdots p_h - sp_k$$

for $s = 0, \dots, p_{k+1} \cdots p_h$ and

(iii) *has right side boundary components of the following form:*

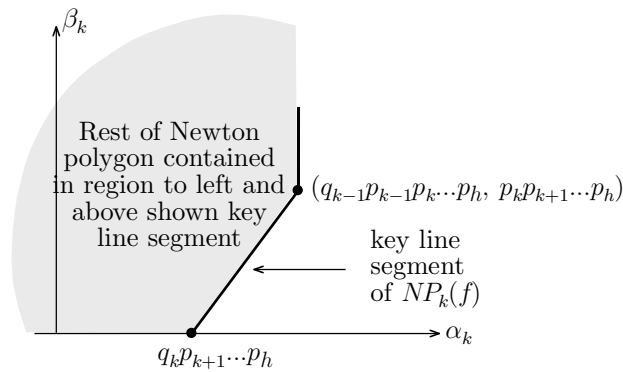

(iv) *is such that $q_k \neq 0$.*

Proof. We use induction for (i), (ii), and (iii). From equation 3.3 we have a quasi-homogeneous polynomial which corresponds to the key line segment in $NP_1(f)$ being

$$(y^{p_1} - t_1^{p_1}x^{q_1})^{p_2p_3 \cdots p_h}.$$

Our first substitution is

$$x = x_2^{p_1}, \quad y = x_2^{q_1}(t_1 + y_2).$$

The quasi-homogeneous polynomial becomes

$$x_2^{q_1 p_1} ((t_1 + y_2)^{p_1} - t_1^{p_1})^{p_2 p_3 \cdots p_h}.$$

The powers of the terms in this lie on the vertical line segment $\alpha_2 = q_1 p_1 p_2 \cdots p_h$, $p_2 \cdots p_h \leq \beta_2 \leq p_1 p_2 \cdots p_h$ which forms part of the right boundary of $NP_2(f)$. All other key points satisfy $\alpha_2 < q_1 p_1 p_2 \cdots p_h$.

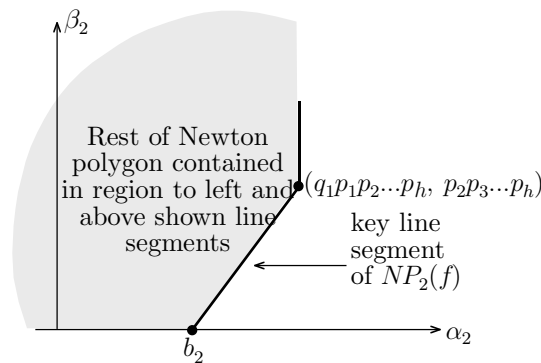

As the curve, C , has just one place at infinity, there is just one key line segment in $NP_2(f)$ and this has slope p_2/τ_2 where $\tau_2 = p_1 q_1 p_2 - q_2$. The corresponding terms in f_2 are

$$c_2 x_2^{q_1 p_1 \cdots p_k} (y_2^{p_2} - t_2^{p_2} x_2^{-\tau_2})^{p_3 \cdots p_h}$$

for some $c_2, t_2 \in \mathbb{C}$, and the result follows.

Now assume that at stage $k - 1$, $NP_{k-1}(f)$ has a key line segment as follows:

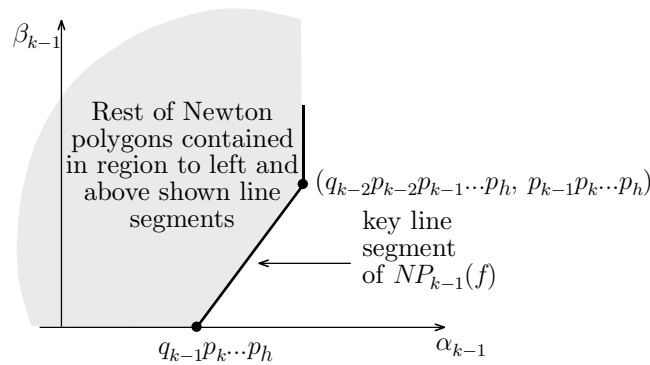

and this key line segment corresponds to a quasi-homogeneous polynomial

$$c_{k-1}x_{k-1}^{q_{k-2}p_{k-2}\cdots p_h}(y_{k-1}^{p_{k-1}} - t_2^{p_{k-1}}x_{k-1}^{-\tau_{k-1}})^{p_k\cdots p_h}.$$

Substituting

$$x_{k-1} = x_k^{p_{k-1}}, \quad y_{k-1} = x_k^{-\tau_{k-1}}(t_{k-1} + y_k),$$

this quasi-homogeneous polynomial becomes

$$\begin{aligned} & (c_{k-1}x_k^{(q_{k-2}p_{k-2}\cdots p_h)p_{k-1}-\tau_{k-1}p_{k-1}\cdots p_h})((t_{k-1} + y_k)^{p_{k-1}} - t_{k-1}^{p_{k-1}})^{p_k p_{k+1}\cdots p_h} \\ & = c_{k-1}x_k^{q_{k-1}p_{k-1}\cdots p_h}((t_{k-1} + y_k)^{p_{k-1}} - t_{k-1}^{p_{k-1}})^{p_k p_{k+1}\cdots p_h} \end{aligned}$$

As the quasi-homogeneous polynomial maps to terms in f_k which match the vertical line segment in the right boundary of $NP_k(f)$, we obtain the corner point as shown:

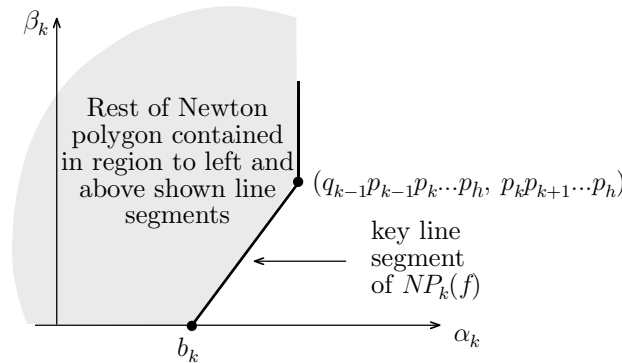

Finally, as the curve, C , has one place at infinity, we have one key line segment of slope p_k/τ_k where $\tau_k = q_{k-1}p_{k-1}p_k - q_k$ with corresponding equation

$$c_k x_k^{q_k p_k \cdots p_h} (y_k^{p_k} - t_k^{p_k} x_k^{-\tau_k})^{p_{k+1} \cdots p_h}$$

which gives the required key points.

For (iv), if $q_k = 0$, we obtain $\tau_k = q_{k-1}p_{k-1}p_k$. But then $\gcd(p_k, \tau_k) \neq 1$ which is a contradiction. \square

3.4. Basic facts about Newton polygons

Lemma 3.11. *Let $f, g \in \mathbb{C}[x, x^{-1}, y]$, $f, g \neq 0$. Let $NP(f)$ denote the Newton polygon of f . Then*

$$NP(fg) = NP(f) + NP(g)$$

where the sum of two sets consists of all the sums of each element in the first set with each element in the second set.

This well known fact is left as an exercise in many references and a proof is presented in Schinzel ([26, Theorem 18, page 89]).

Corollary 3.12. *The Newton polygon of f^n is similar to the Newton polygon of f .*

We will need to have some understanding of how the corner point of fg relates to the corner points of f and g .

Corollary 3.13. *If f is such that $NP(f)$ has a key line segment with corner point (b, c) and point on the horizontal axis, $(a, 0)$, and g is such that $NP(g)$ has a corner point on the horizontal axis, $(d, 0)$:*

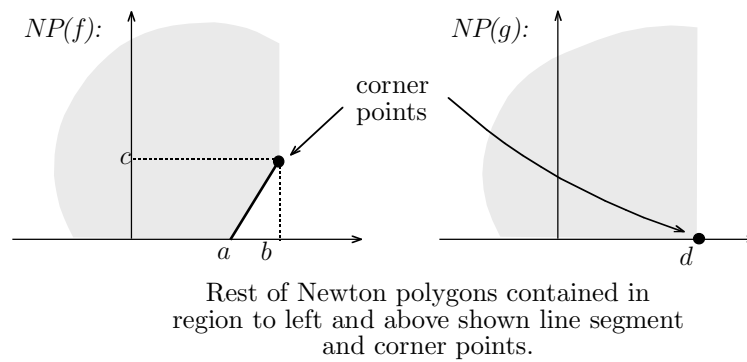

then $NP(fg)$ has a key line segment from $(a + d, 0)$ to $(b + d, c)$, with the latter point being the corner point:

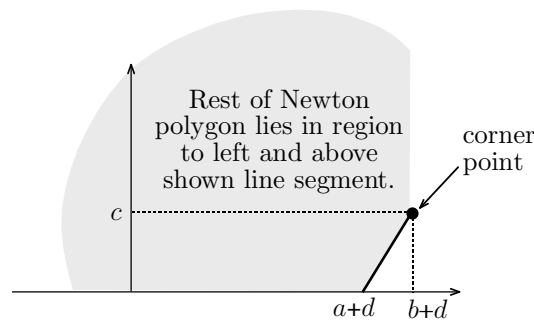

If f is such that $NP(f)$ has a corner point on the horizontal axis at $(d, 0)$, and g is such that $NP(g)$ has no key line segment and has a corner point at (b, c) :

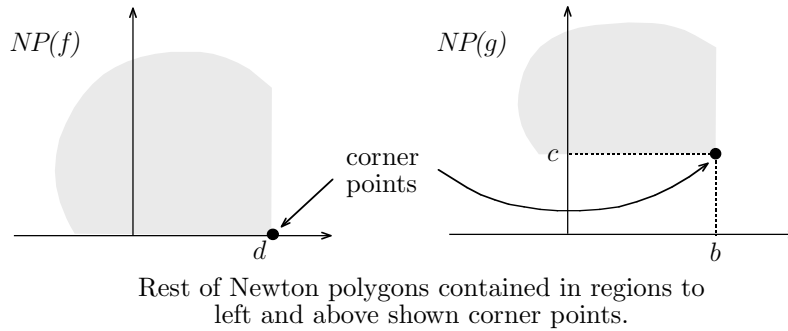

then $NP(fg)$ has no key line segment and has a corner point at $(b + d, c)$:

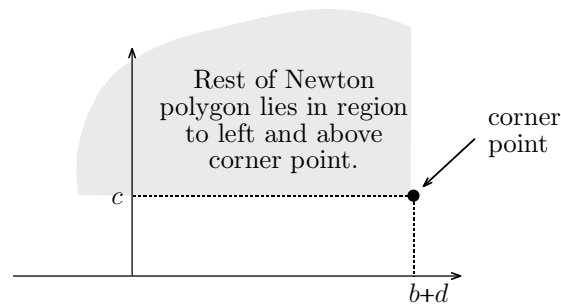

Lemma 3.14. Assume that we have a key line segment of non-zero slope in the boundary of $NP(f)$ with key points (α_1, β_1) and (α_2, β_2) such that

- (α_1, β_1) is the end point of the line segment for which β_1 is maximum and
- (α_2, β_2) is the nearest key point to (α_1, β_1) on the line segment.

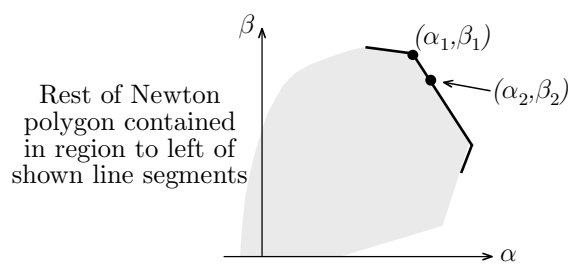

Then $\text{NP}(f^m)$ will have key points in its boundary at

$$(m\alpha_1, m\beta_1) \quad \text{and} \quad (m\alpha_1 - (\alpha_1 - \alpha_2), m\beta_1 - (\beta_1 - \beta_2)).$$

Proof. The terms in f corresponding to the line segment will be of the form

$$a_1x^{\alpha_1}y^{\beta_1} + a_2x^{\alpha_2}y^{\beta_2} + \sum_{\beta < \beta_2} a_\beta x^\alpha y^\beta,$$

$a_1, a_2 \neq 0$. Taking the m^{th} power of this gives

$$(a_1x^{\alpha_1}y^{\beta_1} + a_2x^{\alpha_2}y^{\beta_2})^m + r$$

where

$$r = \sum_{j=1}^m \binom{m}{j} (a_1x^{\alpha_1}y^{\beta_1} + a_2x^{\alpha_2}y^{\beta_2})^{m-j} \left(\sum_{\beta < \beta_2} a_\beta x^\alpha y^\beta \right)^j.$$

As $\deg_y(r) < \beta_1(m - j) + j\beta_2$ this has no term

$$y^{\beta_1 m} \quad \text{or} \quad y^{\beta_1(m-1)+\beta_2}$$

with non-zero coefficient in $\mathbb{C}[x^{-1}, x, y]$. However

$$(a_1x^{\alpha_1}y^{\beta_1} + a_2x^{\alpha_2}y^{\beta_2})^m$$

does have such a term with non-zero coefficient. □

3.5. Technical lemmas

In this section we use induction to establish the technical lemmas used in the proof of Theorem 1.1.

Remark. We show that for $i = 1, \dots, k$, $\text{NP}_i(g_{k+1})$ has the same key line segment as $\text{NP}_i(f)$ and the terms in $g_{k+1,i}$ and f_i corresponding to this key line segment are the same. This implies that the first k Newton pairs, and hence cabling pairs, of f_i and $g_{k+1,i}$ are identical (Lemmas 3.17 and 3.29). From Lemma 3.17 we see that g_{k+1} , $k = 1, \dots, h - 1$, meets infinity at one point, $y = 0$. In addition, $\deg_y(g_{k+1}) = p_1 p_2 \cdots p_k$, while from above the first k cabling pairs of g_{k+1} are $\{(p_1, q_1), \dots, (p_k, q_k)\}$. Thus the splice diagram for g_{k+1} is

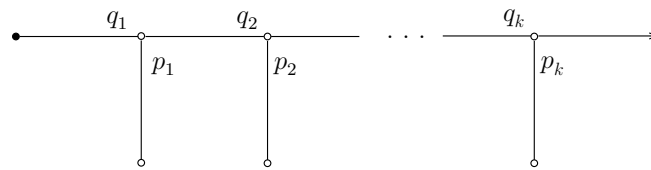

and the link at infinity of g_{k+1} corresponds to the virtual component of the link at infinity of f , S_{v_k} .

We start by establishing what occurs for NP_1 . We use the fact that

$$f = g_1^{p_1 \cdots p_h} + \zeta_1 \quad \text{and} \quad \zeta_1 = \sum a_{\alpha\beta} g_0^\alpha g_1^\beta$$

with $\beta < p_1 \cdots p_h - 1$.

Lemma 3.15. $NP_1(g_1^{p_1 \cdots p_h})$ and $NP_1(a_{\alpha\beta} g_0^\alpha g_1^\beta)$ have no key line segments parallel to that of $NP_1(f)$ and their unique corner points lie within $NP_1(f)$.

Proof. This is obvious as $g_0 = x$ and $g_1 = y$. □

Lemma 3.16. $NP_1(g_{k+1}^{p_{k+1} \cdots p_h})$ is contained within $NP_1(f)$ for $k = 0, \dots, h - 1$ and includes the key point $(0, p_1 \cdots p_h)$.

Proof. Recall that

$$f = g_{k+1}^{p_{k+1} \cdots p_h} + \zeta_{k+1}$$

with $\zeta_{k+1} \in \mathbb{C}[x, y]$, $\deg_y(\zeta_{k+1}) < p_1 \cdots p_h - p_1 \cdots p_k$ and

$$g_{k+1} = g_1^{p_1 \cdots p_k} + \phi$$

with $\deg_y(\phi) < p_1 \cdots p_k - 1$ (Lemma 3.8). Thus $(0, p_1 \cdots p_k)$ is a key point on the boundary of $NP_1(g_{k+1})$. Assume we have a key point in $NP_1(g_{k+1})$, (α', β') say, which satisfies

- $p_1 \alpha' + q_1 \beta' > q_1 p_1 \cdots p_k$,
- (α', β') lies on the boundary of $NP_1(g_{k+1})$,
- β' is the maximum possible such value.

Then $(0, p_1 \cdots p_k)$ and (α', β') lie on the same line segment in the boundary of $NP_1(g_{k+1})$ and there are no key points between them. $NP_1(g_{k+1})$ is as follows:

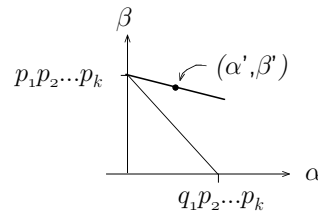

From Lemma 3.14 it follows that $NP_1(g_{k+1}^{p_{k+1}\cdots p_h})$ has key points in its boundary at

$$(0, p_1 \cdots p_h) \quad \text{and} \quad (\alpha', p_1 \cdots p_h - (p_1 \cdots p_k - \beta')).$$

Thus there is a term in $g_{k+1}^{p_{k+1}\cdots p_h}$, $x^{\alpha'} y^{p_1 \cdots p_h - (p_1 \cdots p_k - \beta')}$ with non-zero coefficient. The key point lies outside $NP_1(f)$ as

$$\begin{aligned} p_1 \alpha' + q_1 (p_1 \cdots p_h - (p_1 \cdots p_k - \beta')) &= p_1 \alpha' + q_1 \beta' + q_1 p_1 \cdots p_h - q_1 p_1 \cdots p_k \\ &> q_1 p_1 \cdots p_h \end{aligned}$$

Thus there must be a term in ζ_{k+1} which cancels the term $x^{\alpha'} y^{p_1 \cdots p_h - (p_1 \cdots p_k - \beta')}$. But $\deg_y(\zeta_{k+1}) < p_1 \cdots p_h - p_1 \cdots p_k$ so this is not possible. Thus $NP_1(g_{k+1}^{p_{k+1}\cdots p_h})$ is contained in $NP_1(f)$. \square

Lemma 3.17. For $k = 1, \dots, h - 1$, $NP_1(g_{k+1}^{p_{k+1}\cdots p_h})$ has the same key line segment as $NP_1(f)$ and the terms in $g_{k+1}^{p_{k+1}\cdots p_h}$ and f corresponding to these are identical.

Proof. As $NP_1(g_{k+1}^{p_{k+1}\cdots p_h})$ is contained in $NP_1(f)$, $NP_1(g_{k+1})$ is contained in the given region:

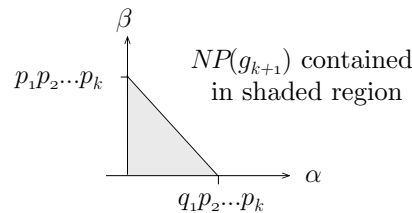

Thus

$$g_{k+1} = \sum_{i=0}^{p_2 \cdots p_k} d_i x^{q_1 i} y^{p_1 (p_2 \cdots p_k - i)} + \sum_{p_1 \alpha + q_1 \beta < q_1 p_1 \cdots p_k} d_{\alpha\beta} x^\alpha y^\beta$$

for some $d_i, d_{\alpha\beta} \in \mathbb{C}$. Note that $d_0 = 1$. Take the $(p_{k+1} \cdots p_h)^{\text{th}}$ power of this to obtain

$$g_{k+1}^{p_{k+1}\cdots p_h} = \left(\sum_{i=0}^{p_1 \cdots p_k} d_i x^{q_1 i} y^{p_1 (p_2 \cdots p_k - i)} \right)^{p_{k+1}\cdots p_h} + \sum_{p_1 \alpha + q_1 \beta < q_1 p_1 \cdots p_k} d'_{\alpha\beta} x^\alpha y^\beta.$$

Equate $g_{k+1}^{p_{k+1}\cdots p_h} + \zeta_{k+1}$ to

$$\begin{aligned} f &= (y^{p_1} - t_1^{p_1} x^{q_1})^{(p_2 \cdots p_k)(p_{k+1}\cdots p_h)} + \sum_{p_1 \alpha + q_1 \beta < q_1 p_1 \cdots p_k} a'_{\alpha\beta} x^\alpha y^\beta \\ &= \left(\sum_{j=0}^{p_2 \cdots p_k} \binom{p_2 \cdots p_k}{j} (y^{p_1})^{(p_2 \cdots p_k - j)} (t_1^{p_1} x^{q_1})^j \right)^{p_{k+1}\cdots p_h} + \sum_{p_1 \alpha + q_1 \beta < q_1 p_1 \cdots p_k} a'_{\alpha\beta} x^\alpha y^\beta \end{aligned}$$

As $\deg_y(\zeta_{k+1}) < p_1 \cdots p_h - p_1 \cdots p_k$, the terms with y -degree greater than $p_1 \cdots p_h - p_1 \cdots p_k$ in $g_{k+1}^{p_{k+1} \cdots p_h}$ and f must be equal. Hence

$$d_0 y^{p_1 \cdots p_h} + (p_{k+1} \cdots p_h) y^{p_1 \cdots p_k (p_{k+1} \cdots p_h - 1)} \sum_{i=1}^{p_2 \cdots p_k} d_i (x^{q_1})^i (y^{p_1})^{(p_2 \cdots p_k - i)}$$

$$= y^{p_1 \cdots p_h} + (p_{k+1} \cdots p_h) y^{p_1 \cdots p_k (p_{k+1} \cdots p_h - 1)} \sum_{j=1}^{p_2 \cdots p_k} \binom{p_{k+1} \cdots p_h}{j} (t_1^{p_1} x^{q_1})^j y^{p_1 (p_2 \cdots p_h - j)}$$

This uniquely determines the d_i in terms of $t_1^{p_1}$ and we get the required values for each d_i . \square

Before looking at the more general case we need the following result.

Lemma 3.18. *Let $f \in \mathbb{C}[x, y]$ have one place at infinity and $g_j \in \mathbb{C}[x^{-1}, x, y]$. Assume that the key line segment of $\text{NP}_j(f)$ is as follows:*

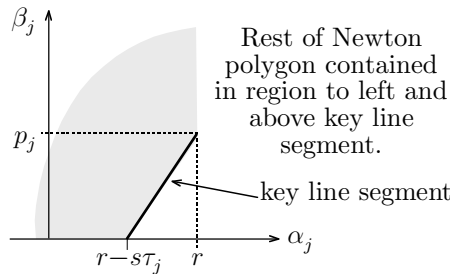

Assume that $\text{NP}_j(g) = \text{NP}(g_j)$ has no key line segment that is parallel to that of $\text{NP}_j(f)$. Let $\phi : (x_j, y_j) \mapsto (x_{j+1}^{p_j}, x_{j+1}^{-\tau_j} (y + t_j))$ be the substitution to be used to find the next Newton pair of f .

Then $\text{NP}(g_j \circ \phi) = \text{NP}(g_{j+1})$ has a corner point on the horizontal axis with all other points in the Newton polygon lying above and to the left of that point.

Proof. The key line segment of $\text{NP}_j(f)$ matches the following terms in f_j

$$a x_j^r (y_j^{p_j} - t_j^{p_j} x_j^{-\tau_j})^s$$

for some constant a . Then g_j can be expressed as

$$g_j = c x_j^{\alpha'} y_j^{\beta'} + \sum_{p_j \alpha - \tau_j \beta < p_j \alpha' - \tau_j \beta'} d_{\alpha\beta} x_j^\alpha y_j^\beta$$

for some $c, d_{\alpha\beta} \in \mathbb{C}$. Put

$$(x_j, y_j) = (x_{j+1}^{p_j}, x_{j+1}^{-\tau_j} (y_{j+1} + t_j))$$

to obtain

$$g_{j+1} = cx_{j+1}^{\alpha' p_j - \beta' \tau_j} (y_{j+1} + t_j)^{\beta'} + \sum_{p_j \alpha - \tau_j \beta < p_j \alpha' - \tau_j \beta'} d_{\alpha\beta} x_{j+1}^{\alpha p_j - \beta \tau_j} (y_{j+1} + t_j)^\beta.$$

One of the terms in $x_{j+1}^{\alpha' p_j - \beta' \tau_j} (y_{j+1} + t_j)^{\beta'}$ gives a point lying in the right boundary of $NP_{j+1}(g)$ at $(\alpha' p_j - \beta' \tau_j, 0)$. This point lies on the α_{j+1} -axis as follows:

$NP(g_j)$:

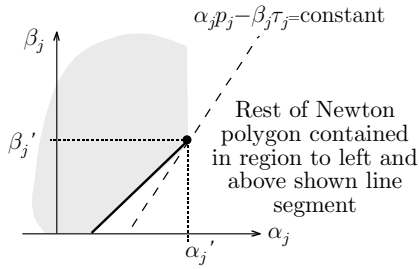

$NP(g_{j+1})$:

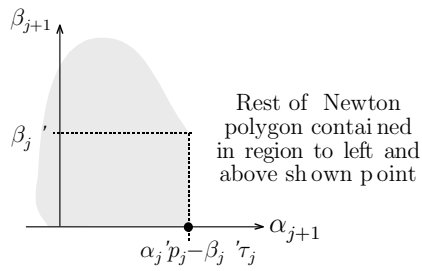

□

Now assume that we have established the following:

- (i) that $NP_{k-1}(g_0) = NP_{k-1}(x)$ is a point on the α_{k-1} -axis, $(p_1 p_2 \cdots p_{k-2}, 0)$.
- (ii) that for $j = 1, 2, \dots, k-2$, $NP_{k-1}(g_j)$ has corner point, $(q_j p_{j+1} \cdots p_{k-2}, 0)$ with all other points in the Newton polygon lying above or to the left of that point.

$NP_{k-1}(g_0)$:

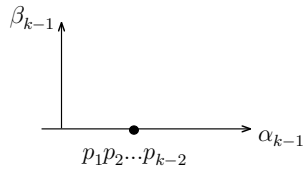

$NP_{k-1}(g_j), j=1, \dots, k-2$:

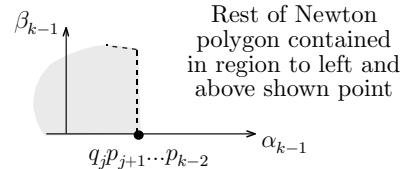

- (iii) that $NP_{k-1}(g_{k-1})$ has a key line segment which is not parallel to the key line segment of $NP_{k-1}(f)$ and has corner point $(p_{k-1} q_{k-2}, 1)$.
- (iv) that $NP_{k-1}(g_k^{p_k \cdots p_h})$ and $NP_{k-1}(f)$ have the same key line segments, and that the terms in f which give this key line segment are also terms of $g_k^{p_k \cdots p_h}$. This means that $NP_{k-1}(g_k)$ has a key line segment from $(q_{k-1}, 0)$ to $(p_{k-2} q_{k-2} p_{k-1}, p_{k-1})$.

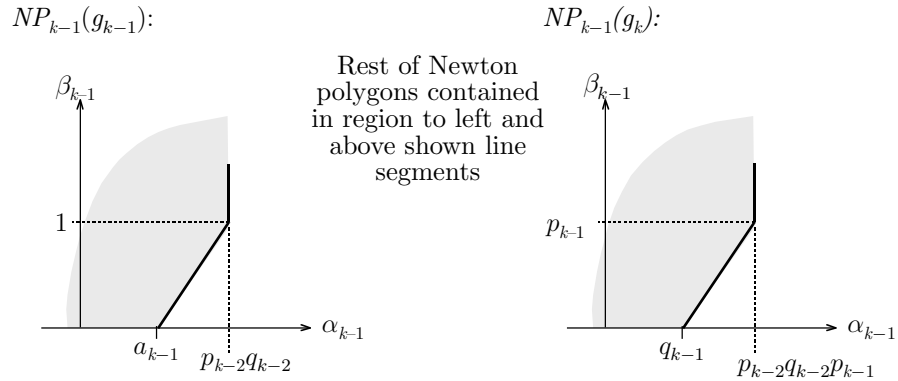

Lemma 3.19. *Then*

- (i) $NP_k(g_0) = NP_k(x)$ is a point on the α_k -axis, $(p_1p_2 \cdots p_{k-1}, 0)$.
- (ii) for $j = 1, 2, \dots, k - 2$, $NP_k(g_j)$ has corner point, $(q_jp_{j+1} \cdots p_{k-1}, 0)$ with all other points in the Newton polygon lying above or to the left of that point.

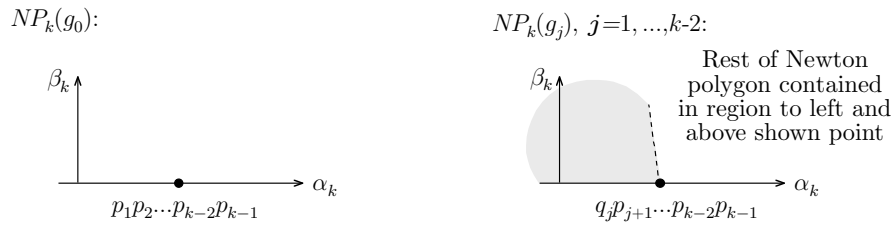

- (iii) $NP_k(g_{k-1})$ has right boundary which is a vertical line with corner point $(q_{k-1}, 0)$.
- (iv) $NP_k(g_k^{p_k \cdots p_h})$ has corner point $(p_{k-1}q_{k-1}, 0)$ and the key line segment of $NP_k(f)$ is not parallel to the key line segment of $NP_k(g_k)$ if it exists.

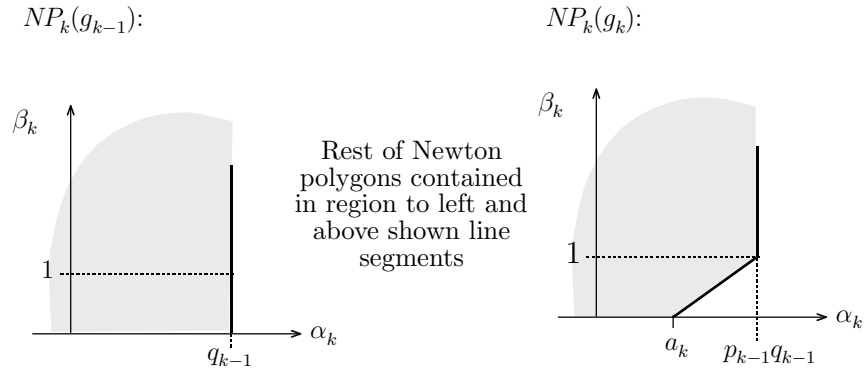

Proof. (i), (ii), and (iii) follow from Lemma 3.18.

To prove (iv), express $g_{k,k-1}$ in the form

$$c_k x_{k-1}^{p_{k-2}q_{k-2}p_{k-1}} (y_{k-1}^{p_{k-1}} - t_{k-1}^{p_{k-1}} x_{k-1}^{-\tau_{k-1}}) + \sum_{\alpha_{k-1}p_{k-1} - \beta_{k-1}\tau_{k-1} < q_{k-1}p_{k-1}} d_{\alpha_{k-1}\beta_{k-1}} x_{k-1}^{\alpha_{k-1}} y_{k-1}^{\beta_{k-1}}.$$

for some constant c_k . When we let

$$(x_{k-1}, y_{k-1}) = (x_k^{p_{k-1}}, x_k^{-\tau_{k-1}}(y_k + t_{k-1}))$$

we obtain

$$g_{k,k} = c_k x_k^{p_{k-1}(p_{k-2}q_{k-2}p_{k-1} - \tau_{k-1})} ((y_k + t_{k-1})^{p_{k-1}} - t_{k-1}^{p_{k-1}}) + \sum_{\alpha_{k-1}p_{k-1} - \beta_{k-1}\tau_{k-1} < q_{k-1}p_{k-1}} d_{\alpha_{k-1}\beta_{k-1}} x_k^{p_{k-1}\alpha_{k-1} - \beta_{k-1}\tau_{k-1}} (y_k + t_{k-1})^{\beta_{k-1}}.$$

Thus, as $p_{k-2}q_{k-2}p_{k-1} - \tau_{k-1} = q_{k-1}$, the corner point is as required.

Assume that $NP_k(g_k)$ has a key line segment parallel to that of $NP_k(f)$. Note that in this case $NP_k(g_k)$ must include a point on the horizontal axis, $(a_k, 0)$, say. Now compare $NP_k(f)$ with $NP_k(g_k^{p_k \cdots p_h})$. The key line segment of $NP_k(f)$ has slope p_k/τ_k where $q_k = q_{k-1}p_{k-1}p_k - \tau_k$ and $\gcd(p_k, \tau_k) = 1$.

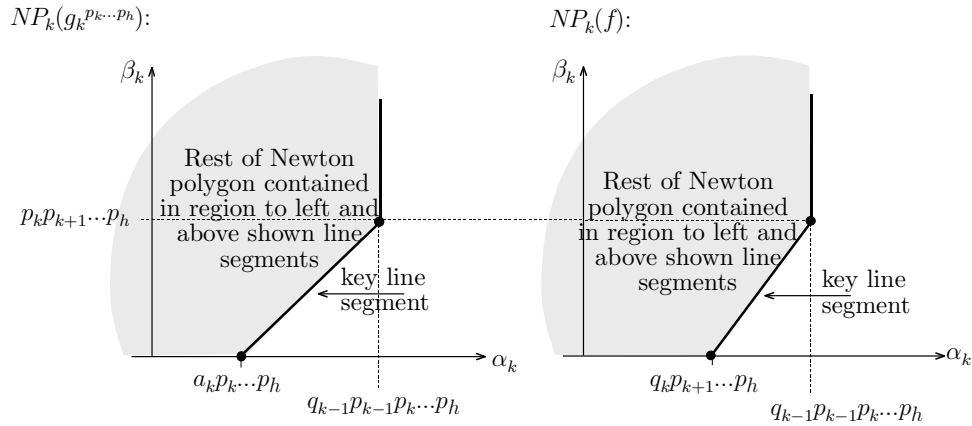

From Corollary 3.12, $NP_k(g_k^{p_k \cdots p_h})$ has key line segment with slope $(p_k p_{k+1} \cdots p_h) / (a_k p_k p_{k+1} \cdots p_h)$ and we see that this has the same corner point as $NP_k(f)$. Thus if the the key line segments of $NP_k(f)$ and $NP_k(g_k^{p_k \cdots p_h})$ are parallel, they are identical. But then $\tau_k = a_k p_k$ which is not possible because $\gcd(p_k, \tau_k) = 1$ and $p_k > 1$. \square

Corollary 3.20. *The corner point of the term $NP_k(a_{\gamma_0 \cdots \gamma_k} g_0^{\gamma_0} \cdots g_k^{\gamma_k})$ is at (α_k, β_k) where*

$$\alpha_k = \gamma_0 p_1 \cdots p_{k-1} + \gamma_1 q_1 p_2 \cdots p_{k-1} + \cdots + \gamma_{k-1} q_{k-1} + \gamma_k p_{k-1} q_{k-1}$$

and

$$\beta_k = \gamma_k.$$

Lemma 3.21. *If $NP_k(g_k^{p_k \cdots p_h})$ has a key line segment, then it has key points on this line segment at*

$$\alpha_k = q_{k-1} p_{k-1} \cdots p_h - u(q_{k-1} p_{k-1} - a_k), \quad \beta_k = p_k \cdots p_h - u$$

for some $a_k \in \mathbb{C}$, $u = 0, \dots, p_k \cdots p_h$.

Proof. Consider $NP_k(g_k)$ which either has no point on the horizontal axis or does have a point on the horizontal axis, at $(a_k, 0)$ say. It is only the latter case where $NP_k(g_k^{p_k \cdots p_h})$ will have a key line segment. The key line segment of $NP_k(g_k)$ has end points $(q_{k-1} p_{k-1}, 1)$ and $(a_k, 0)$:

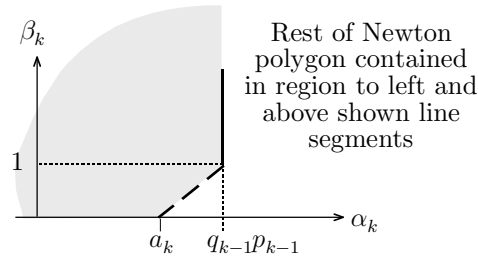

Thus we can express g_k in the form

$$g_k = d_k x_k^{q_{k-1}p_{k-1}} (y_k - r_k x_k) + \sum_{\alpha_k - \beta_k (q_{k-1}p_{k-1} - a_k) < a_k} d_{\alpha_k \beta_k} x_k^{\alpha_k} y_k^{\beta_k}$$

for some $d_k, d_{\alpha_k \beta_k}, r_k \in \mathbb{C}$ with $d_k, r_k \neq 0$. It follows that

$$g_k^{p_k \cdots p_h} = d'_k x_k^{q_{k-1}p_{k-1}p_k \cdots p_h} (y_k - r_k x_k)^{p_k \cdots p_h} + \sum_{\alpha_k - \beta_k (q_{k-1}p_{k-1} - a_k) < a_k p_k \cdots p_h} d'_{\alpha_k \beta_k} x_k^{\alpha_k} y_k^{\beta_k}$$

for some $d'_k, d'_{\alpha_k \beta_k} \in \mathbb{C}$. Therefore, if $NP_k(g_k^{p_k \cdots p_h})$ has a key line segment, it has key points at

$$(q_{k-1}p_{k-1} \cdots p_h - u(q_{k-1}p_{k-1} - a_k), p_k \cdots p_h - u)$$

for $u = 0, 1, \dots, p_k \cdots p_h$.

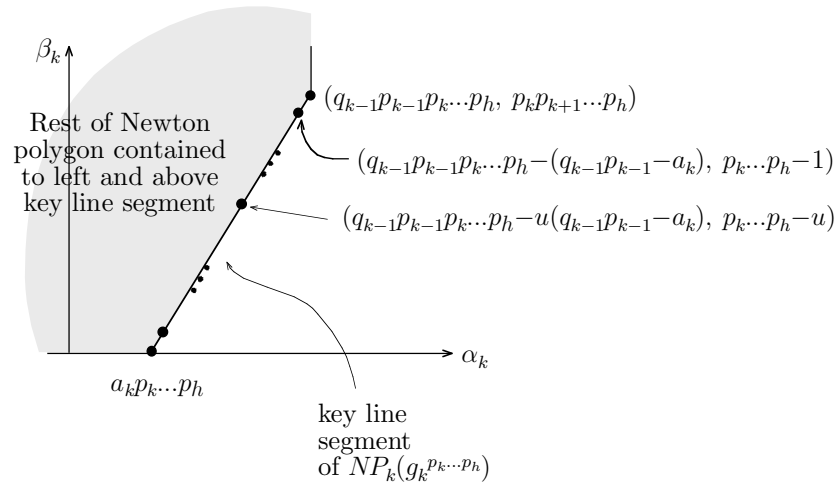

□

Lemma 3.22. *Let $p, q, \phi, \phi', \lambda, \lambda' \in \mathbb{Z}$ and assume that*

- (i) $p \geq 2, q \neq 0,$
- (ii) $\gcd(p, q) = 1$ and
- (iii) $0 \leq \phi, \phi' < p.$

If

$$\lambda p + \phi q = \lambda' p + \phi' q$$

then

$$(\lambda, \phi) = (\lambda', \phi').$$

Proof. Without loss of generality, assume $\phi \geq \phi'$. Then

$$p(\lambda' - \lambda) = q(\phi - \phi')$$

with $0 \leq \phi - \phi' < p$. As $\gcd(p, q) = 1$, p is a factor of $\phi - \phi'$. Thus $\phi - \phi' = 0$ and

$$\phi = \phi'.$$

Hence

$$\lambda' - \lambda = 0. \quad \square$$

Lemma 3.23. *If we have two terms in $f, g_0^{\gamma_0} g_1^{\gamma_1} \cdots g_k^{\gamma_k}$ and $g_0^{\gamma'_0} g_1^{\gamma'_1} \cdots g_k^{\gamma'_k}$ such that*

$$(\gamma_0, \gamma_1, \dots, \gamma_k) \neq (\gamma'_0, \gamma'_1, \dots, \gamma'_k)$$

then

$$\begin{aligned} & (p_1 \cdots p_{k-1} \gamma_0 + q_1 p_2 \cdots p_{k-1} \gamma_1 + \cdots + q_{k-1} \gamma_{k-1} + p_{k-1} q_{k-1} \gamma_k, \gamma_k) \\ & \neq (p_1 \cdots p_{k-1} \gamma'_0 + q_1 p_2 \cdots p_{k-1} \gamma'_1 + \cdots + q_{k-1} \gamma'_{k-1} + p_{k-1} q_{k-1} \gamma'_k, \gamma'_k). \end{aligned}$$

Proof. We prove the contrapositive. Assume

$$\begin{aligned} & (p_1 \cdots p_{k-1} \gamma_0 + q_1 p_2 \cdots p_{k-1} \gamma_1 + \cdots + q_{k-1} \gamma_{k-1} + p_{k-1} q_{k-1} \gamma_k, \gamma_k) \\ & = (p_1 \cdots p_{k-1} \gamma'_0 + q_1 p_2 \cdots p_{k-1} \gamma'_1 + \cdots + q_{k-1} \gamma'_{k-1} + p_{k-1} q_{k-1} \gamma'_k, \gamma'_k). \end{aligned}$$

Then $\gamma_k = \gamma'_k$ and thus

$$\begin{aligned} & p_1 \cdots p_{k-1} \gamma_0 + q_1 p_2 \cdots p_{k-1} \gamma_1 + \cdots + q_{k-1} \gamma_{k-1} \\ & = p_1 \cdots p_{k-1} \gamma'_0 + q_1 p_2 \cdots p_{k-1} \gamma'_1 + \cdots + q_{k-1} \gamma'_{k-1} \end{aligned}$$

so that

$$\begin{aligned} & p_{k-1} (p_1 \cdots p_{k-2} \gamma_0 + q_1 p_2 \cdots p_{k-2} \gamma_1 + \cdots + q_{k-2} \gamma_{k-2}) + q_{k-1} \gamma_{k-1} \\ & = p_{k-1} (p_1 \cdots p_{k-2} \gamma'_0 + q_1 p_2 \cdots p_{k-2} \gamma'_1 + \cdots + q_{k-2} \gamma'_{k-2}) + q_{k-1} \gamma'_{k-1}. \end{aligned}$$

Then, from Lemma 3.22, as $\gcd(p_{k-1}, q_{k-1}) = 1$ and $0 \leq \gamma_{k-1}, \gamma'_{k-1} < p_{k-1}$,

$$\gamma_{k-1} = \gamma'_{k-1}$$

and

$$\begin{aligned} & p_1 \cdots p_{k-2} \gamma_0 + q_1 p_2 \cdots p_{k-2} \gamma_1 + \cdots + q_{k-2} \gamma_{k-2} \\ &= p_1 \cdots p_{k-2} \gamma'_0 + q_1 p_2 \cdots p_{k-2} \gamma'_1 + \cdots + q_{k-2} \gamma'_{k-2}. \end{aligned}$$

Continuing in this fashion we eventually obtain

$$p_1 \cdots p_{k-1} \gamma_0 + q_1 p_2 \cdots p_{k-1} \gamma_1 = p_1 \cdots p_{k-1} \gamma'_0 + q_1 p_2 \cdots p_{k-1} \gamma'_1.$$

Then

$$p_1 \gamma_0 + q_1 \gamma_1 = p_1 \gamma'_0 + q_1 \gamma'_1.$$

From Lemma 3.22,

$$(\gamma_0, \gamma_1) = (\gamma'_0, \gamma'_1)$$

and conclude that

$$(\gamma_0, \gamma_1, \dots, \gamma_k) = (\gamma'_0, \gamma'_1, \dots, \gamma'_k) \quad \square$$

Lemma 3.24. *The key line segments of the terms of f , $\text{NP}_k(a_{\gamma_0 \gamma_1 \dots \gamma_k} g_0^{\gamma_0} g_1^{\gamma_1} \cdots g_k^{\gamma_k})$ where $\gamma_k > 0$*

- (i) *are parallel to each other and are parallel to the key line segment of $\text{NP}_k(g_k^{(p_k \cdots p_h)})$ and*
- (ii) *are not parallel to the key line segment of $\text{NP}_k(f)$.*

Note that if $\gamma_k = 0$, $\text{NP}_k(a_{\gamma_0 \gamma_1 \dots \gamma_k} g_0^{\gamma_0} g_1^{\gamma_1} \cdots g_k^{\gamma_k})$ does not have a key line segment and has a corner point on the horizontal axis.

Proof. (i) This follows directly from Corollary 3.13 and Lemma 3.19.

- (ii) This follows from Lemmas 3.10 and 3.19. □

Let h be a term of f , that is one of $g_k^{p_k \cdots p_h}$ and $a_{\gamma_0 \dots \gamma_k} g_0^{\gamma_0} \cdots g_k^{\gamma_k}$ with $a_{\gamma_0 \dots \gamma_k} \neq 0$.

Lemma 3.25. *Then $\text{NP}_k(h)$ does not have any component to the right of $\text{NP}_k(f)$. That is, for*

$$h = \sum_{\alpha_k, \beta_k} b_{\alpha_k, \beta_k} x_k^{\alpha_k} y_k^{\beta_k},$$

the following holds:

$$\alpha_k p_k - \beta_k \tau_k \leq q_k p_k \cdots p_h$$

and

$$\alpha_k \leq q_{k-1} p_{k-1} \cdots p_h.$$

Proof. First we show that $\text{NP}(g_k^{p_k \cdots p_h})$ has no component to the right of $\text{NP}_k(f)$. There are two cases.

- (i) $\text{NP}_k(g_k)$ is a vertical line only. In this case it is clear that there is no component to the right of $\text{NP}(f)$.
- (ii) $\text{NP}_k(g_k)$ is not a vertical line. In this case assume that $\text{NP}(g_k^{p_k \cdots p_h})$ does have a component to the right of $\text{NP}_k(f)$. Then the key line segments of $\text{NP}_k(f)$ and $\text{NP}_k(g_k)$ will be as follows:

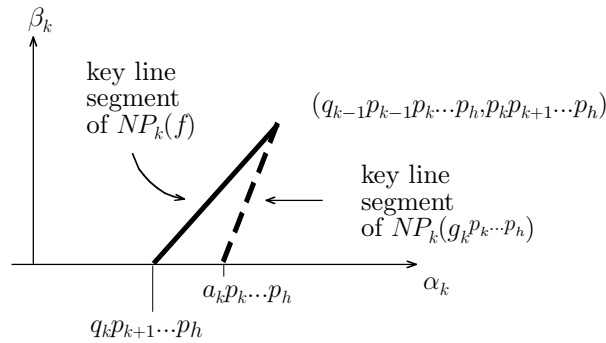

From Lemma 3.21, the key points on the key line segment of $\text{NP}_k(g_k^{p_k \cdots p_h})$ are

$$(q_{k-1} p_{k-1} p_k \cdots p_h - u a_k, p_k \cdots p_h - u)$$

with $u = 0, \dots, p_k \cdots p_h$. (There is a term with non-zero coefficient in $g_k^{p_k \cdots p_h}$ for each of these values.) As these key points lie to the right of $\text{NP}_k(f)$, there must be terms in

$$\zeta_k = f - g_k^{p_k \cdots p_h}$$

having Newton polygons which include the above key points. In particular, there must be one to cancel the term in $g_k^{p_k \cdots p_h}$ corresponding to the key point in $\text{NP}_k(g_k^{p_k \cdots p_h})$, that is to cancel $(q_{k-1} p_{k-1} p_k \cdots p_h - a_k, p_k \cdots p_h - 1)$. Consider the terms of ζ_k , $a_{\gamma_0 \dots \gamma_k} g_0^{\gamma_0} \cdots g_k^{\gamma_k}$. As $\gamma_k < p_k \cdots p_h - 1$, it follows that there is no $\text{NP}_k(a_{\gamma_0 \dots \gamma_k} g_0^{\gamma_0} \cdots g_k^{\gamma_k})$ whose corner point is $(q_{k-1} p_{k-1} p_k \cdots p_h - a_k, p_k \cdots p_h - 1)$. Thus there is a term $a_{\gamma_0 \dots \gamma_k} g_0^{\gamma_0} \cdots g_k^{\gamma_k}$ with non-zero coefficient with corner point lying beyond the right side of $\text{NP}_k(g_k^{p_k \cdots p_h})$, that is, at some (α'_k, β'_k) with $p_k \alpha'_k - a_k p_k \beta'_k > p_k \alpha_k - a_k p_k \beta_k$,

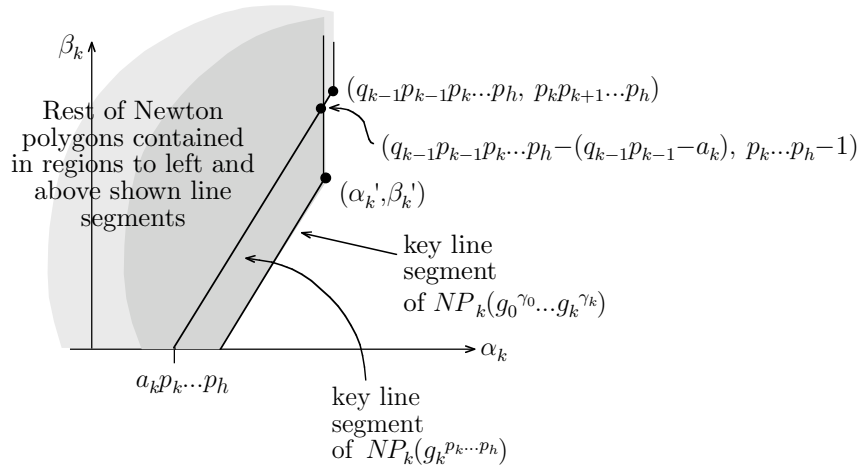

Take the terms $a_{\gamma_0 \dots \gamma_k} g_0^{\gamma_0} \dots g_k^{\gamma_k}$ with $a_{\gamma_0 \dots \gamma_k} \neq 0$ such that $p_k \alpha_k - a_k p_k \beta_k$ is maximum for the corner points, (α_k, β_k) , of $NP_k(a_{\gamma_0 \dots \gamma_k} g_0^{\gamma_0} \dots g_k^{\gamma_k})$. From these choose that term whose corner point has maximum β_k .

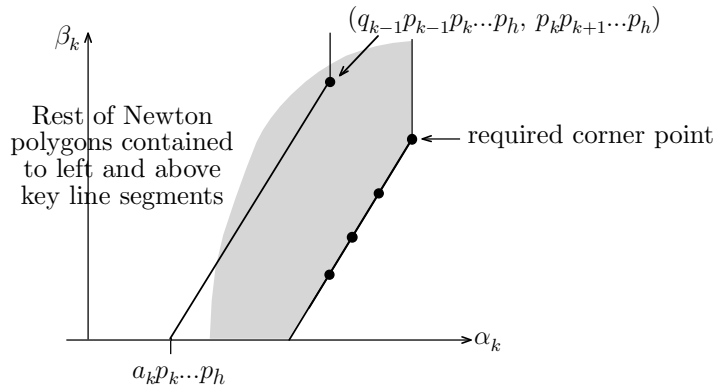

No other term can have a Newton polygon with the same corner point (Lemma 3.23). By construction, this corner point does not lie within the Newton polygon of any other $a_{\gamma_0 \dots \gamma_k} g_0^{\gamma_0} \dots g_k^{\gamma_k}$. Thus this corner point must lie in $NP_k(f)$. But this is a contradiction as we assumed that $NP_k(f)$ has key line segment to the left of the key line segment of $NP_k(g_k^{p_k \dots p_h})$. Hence the key line segment of $NP_k(g_k^{p_k \dots p_h})$ and thus its corner point lie inside $NP_k(f)$.

Secondly, we assume that there is some term $a_{\gamma_0 \dots \gamma_k} g_0^{\gamma_0} \dots g_k^{\gamma_k}$ in ζ_k , with Newton polygon whose corner point lies to the right of $NP_k(f)$. A similar construction to that used above leads to a contradiction and the result follows from the fact that any key line segment of $NP_k(a_{\gamma_0 \dots \gamma_k} g_0^{\gamma_0} \dots g_k^{\gamma_k})$ is parallel to that of $NP_k(g_k^{p_k \dots p_h})$ (Lemma 3.24). \square

Lemma 3.26. *The polynomial*

$$f = g_k^{p_k \cdots p_h} + \sum a_{\gamma_0 \dots \gamma_k} g_0^{\gamma_0} \cdots g_k^{\gamma_k}$$

with $0 \leq \gamma_0, 0 \leq \gamma_1 < p_1, \dots, 0 \leq \gamma_{k-1} < p_{k-1}, 0 \leq \gamma_k < p_k \cdots p_h - 1$, is such that the following terms have non-zero coefficients:

$$\begin{aligned} & \{ a_{\gamma_0 \dots \gamma_k} g_0^{\gamma_0} \cdots g_k^{\gamma_k} \mid \\ & (p_1 p_2 \cdots p_{k-1} \gamma_0 + q_1 p_2 \cdots p_{k-1} \gamma_1 + q_2 p_3 \cdots p_{k-1} \gamma_2 + \cdots + \gamma_k, \gamma_k) \\ & = (q_{k-1} p_{k-1} \cdots p_h - s \tau_k, p_k \cdots p_h - s p_k), \quad s = 1, 2, \dots, p_{k+1} \cdots p_h \} \end{aligned}$$

Proof. Recall that $NP_k(g_k^{p_k \cdots p_h})$ and $\{NP_k(a_{\gamma_0 \dots \gamma_k} g_0^{\gamma_0} \cdots g_k^{\gamma_k}) \mid a_{\gamma_0 \dots \gamma_k} \neq 0\}$

- (i) have unique corner points (Lemma 3.23),
- (ii) either have no key line segment or a key line segment which is not parallel to the key line segment of $NP_k(f)$ (Lemma 3.19),
- (iii) have corner points which lie within $NP_k(f)$ (Lemma 3.25) and
- (iv) f_k has a term with non-zero coefficient for each key point

$$\alpha_k = q_{k-1} p_{k-1} \cdots p_h - s \tau_k \quad \text{and} \quad \beta_k = p_k \cdots p_h - s p_k$$

on the key line segment of $NP_k(f)$ (Lemma 3.10).

Thus there must be terms $a_{\gamma_0 \dots \gamma_k} g_0^{\gamma_0} \cdots g_k^{\gamma_k}$ with non-zero coefficients whose corner points match the key points on the key line segment of f :

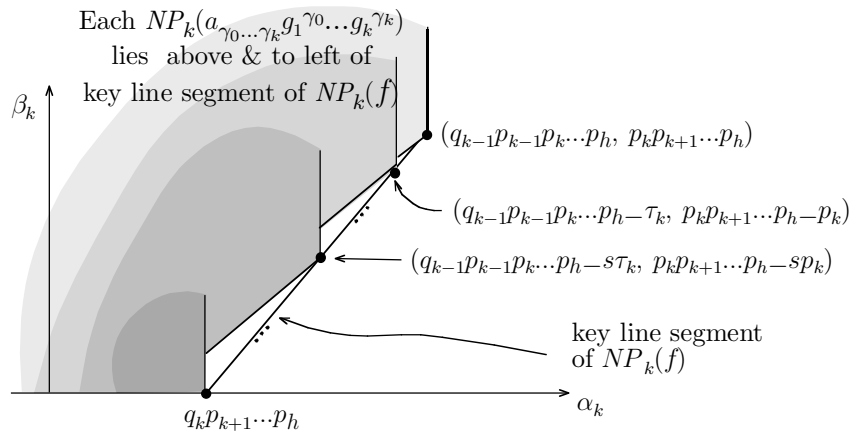

Lemma 3.27. *Assume that for $j = 1, \dots, h - k$, $\text{NP}_{k-1}(g_{k+j}^{p_{k+j} \cdots p_h})$ has the same key line segment as $\text{NP}_{k-1}(f)$ for $i = 1, \dots, k - 1$ and the terms in $g_{k+j,i}^{p_{k+1} \cdots p_h}$ and f_i corresponding to this key line segment are the same.*

Then $\text{NP}_k(g_{k+j}^{p_{k+j} \cdots p_h})$ lies inside $\text{NP}_k(f)$.

Proof. We note that the right vertical line segment in $\text{NP}_k(g_{k+j}^{p_{k+j} \cdots p_h})$ is the same as the right vertical line segment of $\text{NP}_k(f)$ (because $\text{NP}_{k-1}(g_{k+j}^{p_{k+j} \cdots p_h})$ has the same key line segment as $\text{NP}_{k-1}(f)$ for $i = 1, \dots, k - 1$ and the terms in $g_{k+j,i}^{p_{k+1} \cdots p_h}$ and f_i corresponding to this key line segment are the same).

As g_{k+j} is the $(p_{k+j} \cdots p_h)^{\text{th}}$ approximate root of f ,

$$f = g_{k+j}^{p_{k+j} \cdots p_h} + \zeta_{k+j}$$

where $\deg_y(\zeta_{k+j}) < p_1 \cdots p_h - p_1 \cdots p_{k-1+j}$. Using the techniques of Lemma 3.9 we have that

$$\zeta_{k+j} = \sum b_{\eta_0 \dots \eta_k} g_0^{\eta_0} \cdots g_k^{\eta_k}$$

with $\eta_1 < p_1, \dots, \eta_{k-1} < p_{k-1}, \eta_k < p_k \cdots p_h - p_k \cdots p_{k-1+j}$. Assume that $\text{NP}_k(g_{k+j})$ has a point on its boundary, (α'_k, β'_k) such that

- $\alpha'_k p_k - \beta'_k \tau_k > q_k p_k \cdots p_{k+j-1}$ is the maximum possible value and
- β'_k is the maximum for the key points on this line segment.

Then there is a line segment in the boundary of $\text{NP}_k(g_{k+j})$ which includes the key points

$$(q_{k-1} p_{k-1} p_k \cdots p_{k+j-1}, p_k \cdots p_{k+j-1})$$

and

$$(\alpha'_k, \beta'_k)$$

with no other key points in between. Thus, from Lemma 3.14, $\text{NP}_k(g_{k+j}^{p_{k+j} \cdots p_h})$ includes the key point (α_k, β_k) where

$$\alpha_k = q_{k-1} p_{k-1} p_k \cdots p_h - (q_{k-1} p_{k-1} p_k \cdots p_{k+j-1} - \alpha'_k)$$

and

$$\beta_k = p_k \cdots p_h - (p_k \cdots p_{k+j-1} - \beta'_k).$$

This point lies outside $\text{NP}_k(f)$ as

$$\begin{aligned} p_k(q_{k-1} p_{k-1} p_k \cdots p_h - (q_{k-1} p_{k-1} p_k \cdots p_{k+j-1} - \alpha'_k)) \\ - \tau_k(p_k \cdots p_h - (p_k \cdots p_{k+j-1} - \beta'_k)) \\ = q_k p_k \cdots p_h - q_k p_k \cdots p_{k+j-1} + \alpha'_k p_k - \tau_k \beta'_k \\ > q_k p_k \cdots p_h \end{aligned}$$

Thus there must be some $b_{\eta_0 \dots \eta_k} g_0^{\eta_0} \dots g_k^{\eta_k}$ in ζ_{k+j} which cancels this term in $g_{k+1}^{p_{k+1} \dots p_h}$ and therefore a term in ζ_{k+1} with corner point of $\text{NP}_k(b_{\eta_0 \dots \eta_k} g_0^{\eta_0} \dots g_k^{\eta_k})$ lying outside $\text{NP}_k(f)$. If we do the construction as in the proof of Lemma 3.25 we will get a contradiction in exactly the same way. \square

Scholium 3.28. *The terms of ζ_{k+j} , $b_{\eta_0 \dots \eta_k} g_0^{\eta_0} \dots g_k^{\eta_k}$, are such that the corner points of $\text{NP}_k(b_{\eta_0 \dots \eta_k} g_0^{\eta_0} \dots g_k^{\eta_k})$ are inside $\text{NP}_k(f)$ and contained within the region $\alpha_k \leq p_{k-1} p_{k-1} \dots p_h - \tau_k p_{k+1} \dots p_{k+j-1}$.*

Proof. From the last part of the proof of the previous result we see that $\text{NP}_k(\zeta_{k+j})$ has terms, $b_{\eta_0 \dots \eta_k} g_0^{\eta_0} \dots g_k^{\eta_k}$, with corner points lying within $\text{NP}_k(f)$ and with $\eta_k < p_k \dots p_h - p_k \dots p_{k+j-1}$. The result follows. \square

Lemma 3.29. *For $j = 1, \dots, h - k$, $\text{NP}_k(g_{k+j}^{p_{k+j} \dots p_h})$ has the same key line segment as $\text{NP}_k(f)$ and the terms in $g_{k+j,k}^{p_{k+j} \dots p_h}$ and f_k corresponding to these are identical.*

Proof. As $\text{NP}_k(g_{k+j}^{p_{k+j} \dots p_h})$ is contained in $\text{NP}_k(f)$, $\text{NP}_k(g_{k+j})$ is contained in the region

$$\begin{aligned} p_k \alpha_k - \tau_k \beta_k &\leq q_{k-1} p_{k-1} \dots p_{k+j-1} - \tau_k p_{k+1} \dots p_{k+j-1} \\ &= q_k p_k \dots p_{k+j-1} \end{aligned}$$

as shown:

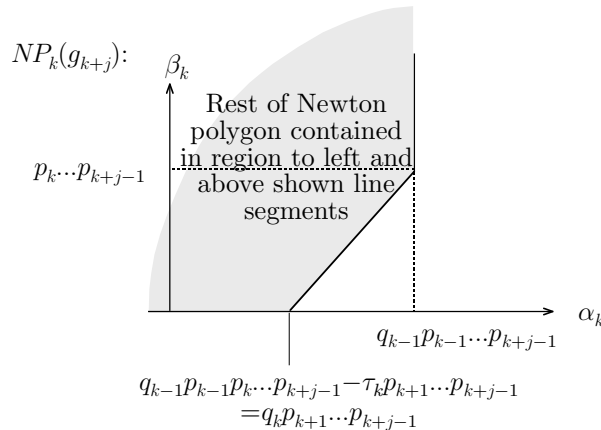

We have

$$g_{k+j,k} = x_k^{q_{k-1} p_{k-1} \dots p_{k+j-1}} \sum_{i=0}^{p_{k+1} \dots p_{k+j-1}} d_i (x_k^{-\tau_k})^i (y_k^{p_k})^{(p_{k+1} \dots p_{k+j-1} - i)} + \sum_{p_k \alpha_k - \tau_k \beta_k < q_{k-1} p_{k-1} \dots p_{k+j-1}} d_{\alpha_k \beta_k} x_k^{\alpha_k} y_k^{\beta_k}$$

for some $d_i, d_{\alpha\beta} \in \mathbb{C}$. Take the $(p_{k+j} \cdots p_h)^{\text{th}}$ power of this to obtain

$$g_{k+1}^{p_{k+j} \cdots p_h} = x_k^{q_{k-1} p_{k-1} \cdots p_h} \left(\sum_{i=0}^{p_{k+1} \cdots p_{k+j-1}} d_i (x_k^{-\tau_k})^i (y_k^{p_k})^{(p_{k+1} \cdots p_{k+j-1} - i)} \right)^{p_{k+1} \cdots p_h} + \sum_{p_k \alpha_k - \tau_k \beta_k < q_{k-1} p_{k-1} \cdots p_h} d'_{\alpha_k \beta_k} x_k^{\alpha_k} y_k^{\beta_k}. \quad (1)$$

Equate $g_{k+j,k}^{p_{k+j} \cdots p_h} + \zeta_{k+j,k}$ to obtain

$$f_k = d_0 x_k^{q_{k-1} p_{k-1} \cdots p_h} (y_k^{p_k} - t_k^{p_{k+1}} x_k^{-\tau_k})^{(p_{k+1} \cdots p_{k+j-1})(p_{k+j} \cdots p_h)} + \sum_{p_k \alpha_k - \tau_k \beta_k < q_{k-1} p_{k-1} \cdots p_h} d'_{\alpha\beta} x_k^{\alpha_k} y_k^{\beta_k} \\ = d x_k^{q_{k-1} p_{k-1} \cdots p_h} \cdot \left(\sum_{m=0}^{p_{k+1} \cdots p_{k+j-1}} \binom{p_{k+1} \cdots p_{k+j-1}}{m} y_k^{p_k (p_{k+1} \cdots p_{k+j-1} - m)} (t_k^{p_{k+1}} x_k^{-\tau_k})^m \right)^{p_{k+j} \cdots p_h} + \sum_{p_k \alpha_k - \tau_k \beta_k < q_{k-1} p_{k-1} \cdots p_h} d'_{\alpha\beta} x_k^{\alpha_k} y_k^{\beta_k} \quad (2)$$

From Scholium 3.28, $\zeta_{k+j,k}$ does not have any terms $x_k^{\alpha_k} y_k^{\beta_k}$ with non-zero coefficient satisfying

$$\alpha_k > q_{k-1} p_{k-1} \cdots p_h - \tau_k p_{k+1} \cdots p_{k+j-1}.$$

Thus we see that the terms in (1) and (2) with degree in $y_k > q_{k-1} p_{k-1} \cdots p_h - \tau_k p_{k+1} \cdots p_{k+j-1}$ satisfying $p_k \alpha_k - \tau_k \beta_k = q_{k-1} p_{k-1} \cdots p_h$ correspond. Thus

$$d_0 y_k^{p_k \cdots p_{k+j-1} (p_{k+j} \cdots p_h)} + (p_{k+j} \cdots p_h) d_0 y_k^{p_k \cdots p_{k+j-1} (p_{k+j} \cdots p_h - 1)} \sum_{i=1}^{p_{k+1} \cdots p_{k+j-1}} d_i x_k^{-\tau_k i} y_k^{p_k (p_{k+1} \cdots p_{k+j-1} - i)} \\ = d y_k^{p_k \cdots p_h} + d (p_{k+j} \cdots p_h) y_k^{p_k \cdots p_{k+j-1} (p_{k+j} \cdots p_h - 1)} \cdot \sum_{i=1}^{p_{k+1} \cdots p_k} \binom{p_{k+j} \cdots p_{k+j-1}}{i} (t_k^{p_k} x_k^{-\tau_k})^i y_k^{p_k (p_{k+1} \cdots p_h - i)}.$$

This uniquely determines the d_i in terms of d and $t_k^{p_k}$ and we get the required values for each d_i . □

3.6. The case of redundant cables

In the previous part of this section we assumed that the minimal splice diagram was the same as the original splice diagram. However this is not always the case as we

may have Newton pairs of the form $(1, s)$ which lead to redundant cables as we build up the link at infinity. To allow for this we replace the assumptions of Section 3.3 by the following:

- (i) $f \in \mathbb{C}^2$ is a polynomial with $f(x, y) = 0$ defining an irreducible curve C with one place at infinity.
- (ii) f has minimal splice diagram:

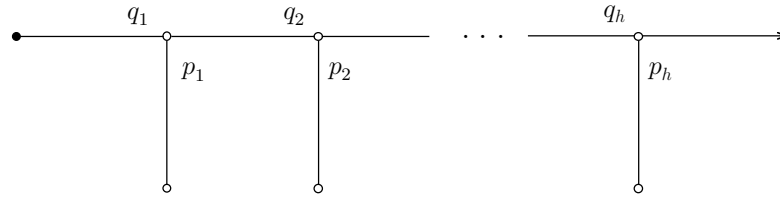

- (iii) The cabling pairs of f include (in the given order)

$$(p_1, q_1), (p_2, q_2), \dots, (p_h, q_h)$$

with $p_i > 1$ for all i while the Newton pairs include

$$(p_1, q_1), (p_2, -\tau_2), \dots, (p_h, -\tau_h).$$

However for one or more values of $k, k > 1$, we find additional Newton pairs

$$(1, -\omega_{k,1}), (1, -\omega_{k,2}), \dots, (1, -\omega_{k,l_k})$$

between $(p_{k-1}, -\tau_{k-1})$ and $(p_k, -\tau_k)$ which lead to redundant cabling pairs

$$(1, s_{k,1}), (1, s_{k,2}), \dots, (1, s_{k,l_k}).$$

The relevant part of the non-reduced splice diagram is

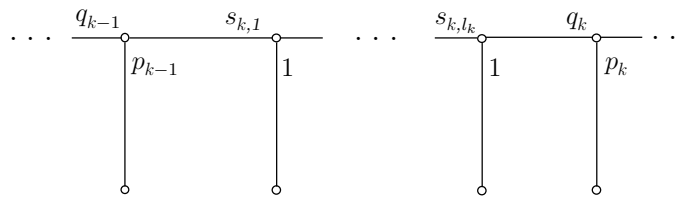

- (iv) In order to find the cabling pairs of f

$$(p_1, q_1), (p_2, q_2), \dots, (p_h, q_h)$$

we make the following substitutions. If there are no additional Newton pairs between $(p_{k-1}, -\tau_{k-1})$ and $(p_k, -\tau_k)$,

$$\Phi_j : (x_{k-1}, y_{k-1}) = (x_k^{p_{k-1}}, x_k^{-\tau_{k-1}}(y_k + t_{k-1}))$$

as before. Where additional Newton pairs occur between $(p_{k-1}, -\tau_{k-1})$ and $(p_k, -\tau_k)$ we make the following substitutions:

- $\Phi_{k-1} : (x_{k-1}, y_{k-1}) = (x_{k,1}^{p_{k-1}}, x_{k,1}^{-\tau_{k-1}}(y_{k,1} + t_{k-1}))$. Thus $s_{k,1} = q_{k-1}p_{k-1} - \tau_{k-1}$.
- $\Omega_{k,j} : (x_{k,j}, y_{k,j}) = (x_{k,j+1}, x_{k,j+1}^{-\omega_{k,j}}(y_{k,j+1} + u_{k,j}))$ for $j = 1, \dots, k_l - 1$ giving $s_{k,j} = s_{k,j-1} - \omega_{k,j}$.
- $\Omega_{k,l_k} : (x_{k,l_k}, y_{k,l_k}) = (x_k, x_k^{-\omega_{k,l_k}}(y_k + u_{k,l_k}))$ giving $q_k = s_{k,l_k}p_k - \tau_k$.

For convenience we call the images of f used at the stages of finding the cabling pairs $(p_1, q_1), (p_2, q_2), \dots, (p_h, q_h)$, by f_1, \dots, f_h as before. We denote the image of f used to determine $\Omega_{k,j}$ by $f_{k,j}$ and the corresponding Newton polygon as $NP_{k,j}(f)$. We carry through the notation of the images and Newton polygons of each g_i under the actions of Φ_i and $\Omega_{k,j}$ in the same way.

We obtain the following Newton polygon after applying Φ_{k-1} :

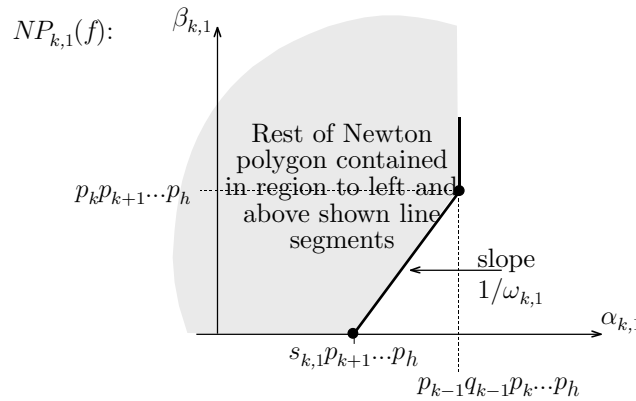

After applying $\Omega_{k,1}, \dots, \Omega_{k,l_k-1}$ we obtain

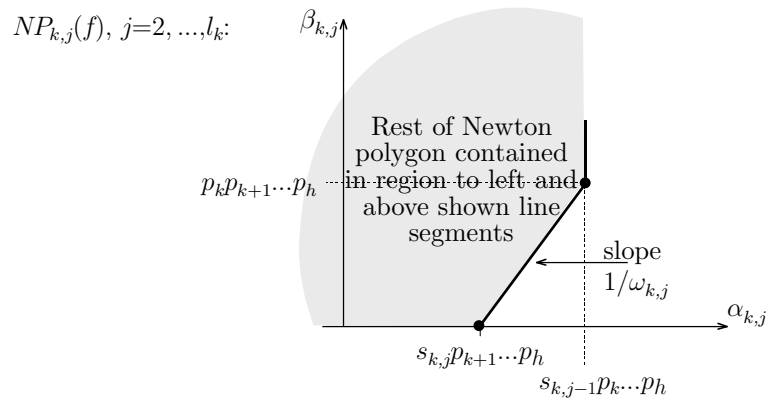

Finally we apply Ω_{k,l_k} to get

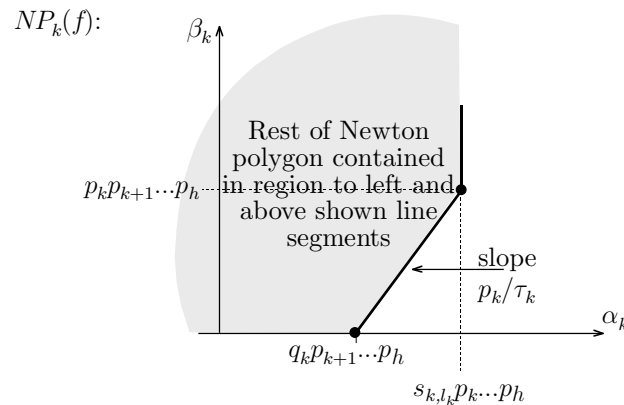

Lemma 3.30. For $i = 0, \dots, k - 1$, the corner points of $NP_{k,j}(g_i)$ are the same as the corner points of $NP_k(g_i), j = 1, \dots, l_k$, which are the same corner points as given in Lemma 3.19, that is,

- (i) $NP_k(g_0)$ and $NP_{k,j}(g_0) = NP_{k,j}(x)$ are points on the horizontal axes, $(p_1 p_2 \dots p_{k-1}, 0)$.
- (ii) $NP_k(g_i)$ and $NP_{k,j}(g_i), i = 1, 2, \dots, k-2$ have corner points, $(q_i p_{i+1} \dots p_{k-1}, 0)$.
- (iii) $NP_k(g_{k-1})$ and $NP_{k,j}(g_{k-1})$ have corner points $(q_{k-1}, 0)$ lying on the horizontal axis.

Proof. Initially we apply Φ_{k-1} as in Lemma 3.19, so that the result is true for $j = 1$. When we apply $\Omega_{k,j}$, the term corresponding to the corner point of $\text{NP}_{k,j}(g_i)$, is of the form $cx_{k,j}^\alpha$ and so maps to $cx_{k,j+1}^\alpha$ as required. \square

Lemma 3.31. *For $i = 0, \dots, h - k$ and $\text{NP}_k(g_{k+i})$ and $\text{NP}_{k,j}(g_{k+i}^{p_{k+i} \cdots p_h})$, $j = 1, \dots, l_k$, have the same key line segments as $\text{NP}_k(f)$ and $\text{NP}_{k,j}(f)$ respectively and the terms in $g_{k+i,k,j}^{p_{k+i} \cdots p_h}$ and $f_{k,j}$ corresponding to these are identical.*

Proof. (i)

$$f_{k,1} = c_1 x_{k,1}^{q_{k-1} p_{k-1} \cdots p_h} (y_{k,1} - u_{k,1} x_{k,1}^{-\omega_{k,1}})^{p_k \cdots p_h} + \sum_{\alpha_{k,1} - \omega_{k,1} \beta_{k,1} < s_1 p_k \cdots p_h} d_{\alpha_{k,1} \beta_{k,1}} x_{k,1}^{\alpha_{k,1}} y_{k,1}^{\beta_{k,1}}$$

and

$$f_{k,j} = c_j x_{k,j}^{s_{j-1} p_k \cdots p_h} (y_{k,j} - u_{k,j} x_{k,j}^{-\omega_{k,j}})^{p_k \cdots p_h} + \sum_{\alpha_{k,j} - \omega_{k,j} \beta_{k,j} < s_{k,j} p_k \cdots p_h} d_{\alpha_{k,j} \beta_{k,j}} x_{k,j}^{\alpha_{k,j}} y_{k,j}^{\beta_{k,j}}$$

for $j = 2, \dots, l_k$, $f_{k,j}$ has a term, $x_{k,j}^{s_j p_k \cdots p_h - \omega_{k,j}} y^{p_k \cdots p_h - 1}$, with non-zero coefficient.

(ii) By the arguments in the proofs of Lemmas 3.27 and 3.25 the right boundary of $\text{NP}_{k,j}(g_{k+i}^{p_{k+i} \cdots p_h})$, lies inside $\text{NP}_{k,j}(f)$ for $i = 0, \dots, h - k$.

Given these two items we can use the same argument as Lemma 3.29 to obtain the desired result. \square

Lemmas 3.31 and 3.30 ensure that the results proved in the technical lemmas needed to prove the Abhyankar-Moh semi-group theorem still hold, that is,

(i) that the terms of f with non-zero coefficients have Newton polygons with corner points occurring at (α_k, β_k) where

$$\begin{aligned} \alpha_k &= p_1 \cdots p_{k-1} \gamma_0 + q_1 p_2 \cdots p_{k-1} \gamma_1 + \cdots + q_{k-1} \gamma_{k-1} + s_{k,l_k} \gamma_k, \\ \beta_k &= \gamma_k \end{aligned}$$

(ii) that there is some term in f

$$a_{\gamma'_0 \cdots \gamma'_k} g_0^{\gamma'_0} \cdots g_k^{\gamma'_k}$$

$a_{\gamma'_0 \cdots \gamma'_k} \neq 0$ whose Newton polygon $\text{NP}_k(a_{\gamma'_0 \cdots \gamma'_k} g_0^{\gamma'_0} g_1^{\gamma'_1} \cdots g_k^{\gamma'_k})$ has corner point at the key point on the boundary of $\text{NP}_k(f)$, (α_k, β_k) with

$$\begin{aligned} \alpha_k &= s_{k,l_k} p_k \cdots p_h - \tau_k, \\ \beta_k &= p_k \cdots p_h - p_k \end{aligned}$$

where $q_k = s_{k,l_k} p_k - \tau_k$.

Proof of Theorem 1.1. The proof is the same for $k = 1$ as

$$\psi_1 = q_1 p_1 \cdots p_h$$

and

$$\delta_0 = p_1 \cdots p_h$$

so that

$$\psi_1 \in \text{semi-group}\{\delta_0\}.$$

Under our new assumptions

$$\gamma'_k = p_k \cdots p_h - p_k$$

and

$$p_1 \cdots p_{k-1} \gamma'_0 + q_1 p_2 \cdots p_{k-1} \gamma'_1 + \cdots + q_{k-1} \gamma'_{k-1} + s_{k,l_k} \gamma'_k = s_{k,l_k} p_k \cdots p_h - \tau_k.$$

Therefore

$$p_1 \cdots p_{k-1} \gamma'_0 + q_1 p_2 \cdots p_{k-1} \gamma'_1 + \cdots + q_{k-1} \gamma'_{k-1} + s_{k,l_k} (p_k \cdots p_h - p_k) = s_{k,l_k} p_k \cdots p_h - \tau_k$$

and thus

$$p_1 \cdots p_{k-1} \gamma'_0 + q_1 p_2 \cdots p_{k-1} \gamma'_1 + \cdots + q_{k-1} \gamma'_{k-1} = s_{k,l_k} p_k - \tau_k = q_k.$$

Multiply each side by $p_k \cdots p_h$ to obtain

$$\delta_0 \gamma'_0 + \delta_1 \gamma'_1 \cdots \delta_{k-1} \gamma'_{k-1} = \psi_k.$$

As $\gamma'_i \geq 0$, for all i , the result follows and

$$\psi_k \in \text{semi-group}\{\delta_0, \dots, \delta_{k-1}\}. \quad \square$$

4. The semi-group conditions for one point at infinity

In section 3 the main assumption underlying the proof of the Abhyankar-Moh semi-group theorem (Theorem 1.1) is that, for $f \in \mathbb{C}[x, y]$, the curve defined by with $f(x, y) = 0$ is an irreducible algebraic curve in the complex plane \mathbb{C}^2 with “one place at infinity.” Alternatively the minimal link at infinity is of the following form

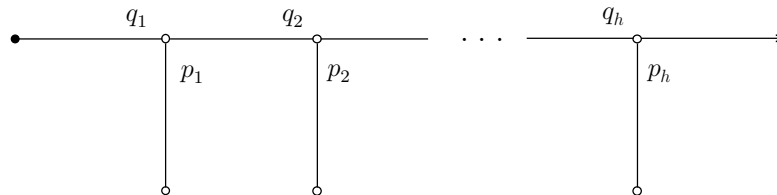

There are two key consequences of this assumption that are used to prove Theorem 1.1:

- (i) f is monic in y so that we can find approximate roots of f , and
- (ii) the Newton polygons of f each have one key line segment and give just one Newton pair corresponding to one branch in the splice diagram.

This leads to the intriguing question: can we find descriptions of the linking numbers for curves in other cases? The answer is that we can indeed find partial descriptions in two cases. In particular, in this section we give a description for the case of *one point at infinity*, but more than one branch at the h^{th} node.

In this situation, at some node, say, the h^{th} node the cabling operation consists of adding l parallel (p_h, q_h) cables, $l \geq 1$. The splice diagram is

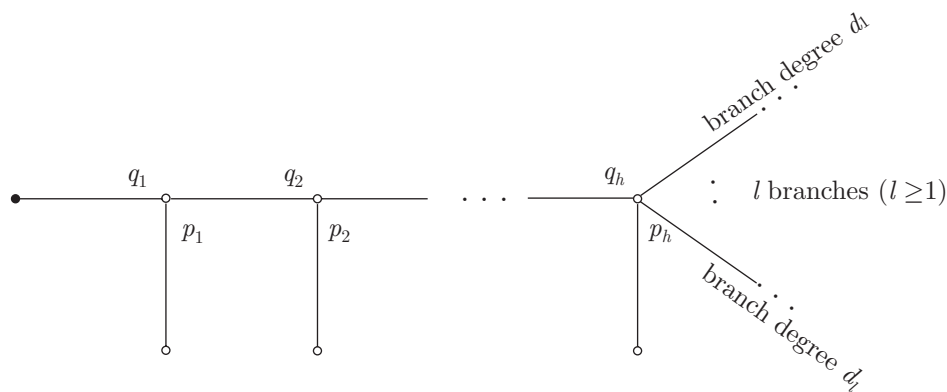

either with $l = 1$ and $p_1, \dots, p_h \geq 2$ or with $l \geq 2$, $p_1, \dots, p_{h-1} \geq 2$, and $p_h \geq 1$. The above splice diagram is minimal except unless $l \geq 2$ and $p_h = 1$.

Note that the branch degree is found as follows. Let v be a node in Γ and select a number of edges adjoining v . Let w_1, \dots, w_r be the arrowheads in that part of the splice diagram which lie along and beyond the selected edges. Then the *branch degree* is $\sum_{i=1}^r l(v, w_i)$ where $l(v, w_i)$ is the product of the edge weights adjacent to but not on the path from v to w_i .

Let $\sum_{i=1}^l d_i = d$. Name the vertices in the diagram above as follows. Starting from the root vertex and moving towards the branching vertex:

- vertices with one adjoining edge are u_0, u_1, \dots, u_h
- vertices with three or more adjoining edges are v_1, v_2, \dots, v_h

Let S_{u_i} and S_{v_i} denote the virtual components of the link corresponding to the nodes $\{u_i\}_{i=0}^h$ and $\{v_j\}_{j=1}^h$ respectively. Then name the linking numbers of the virtual

components with L , the link at infinity, by

$$\begin{aligned} \delta_0 &= l_{u_0} = \text{link}(S_{u_0}, L) = p_1 p_2 \cdots p_h d, \\ \delta_1 &= l_{u_1} = \text{link}(S_{u_1}, L) = q_1 p_2 p_3 \cdots p_h d, \\ \delta_2 &= l_{u_2} = \text{link}(S_{u_2}, L) = q_2 p_3 p_4 \cdots p_h d, \\ &\vdots \\ \delta_h &= l_{u_h} = \text{link}(S_{u_h}, L) = q_h d, \end{aligned}$$

and

$$\begin{aligned} \psi_1 &= l_{v_1} = \text{link}(S_{v_1}, L) = q_1 p_1 p_2 \cdots p_h d, \\ \psi_2 &= l_{v_2} = \text{link}(S_{v_2}, L) = q_2 p_2 p_3 \cdots p_h d, \\ &\vdots \\ \psi_h &= l_{v_h} = \text{link}(S_{v_h}, L) = q_h p_h d. \end{aligned}$$

Theorem 1.2. *Let $f \in \mathbb{C}[x, y]$ be an irreducible polynomial that defines a curve $f(x, y) = 0$ with one point at infinity. Then, using the above notation we have*

(i) For $i = 1, \dots, h - 1$,

$$\psi_i \in \text{semi-group}\{\delta_0, \delta_1, \dots, \delta_{i-1}\}$$

and

(ii) there exists $r \in \mathbb{Z}$ such that $1 \leq r \leq l$ such that

$$r\psi_h \in \text{semi-group}\{\delta_0, \delta_1, \dots, \delta_{h-1}\}.$$

The following lemma is used in the proof of this theorem.

Lemma 4.1. *Let $w \in \mathbb{C}[z]$ have exactly l distinct roots, with $l > 1$ and assume $w(z) = z^n + a_{n-1}z^{n-1} + \cdots + a_0$. Then at least one of $a_{n-1}, a_{n-2}, \dots, a_{n-l} \neq 0$.*

Proof. Assume that

$$w(z) = \prod_{i=1}^n (z - b_i) = \prod_{j=1}^l (z - c_j)^{d_j}$$

where b_1, b_2, \dots, b_n are the roots of w repeated according to multiplicity and c_1, \dots, c_l are the l distinct roots. We prove the result by contradiction. Assume

$$a_{n-1} = a_{n-2} = \cdots = a_{n-l} = 0.$$

Now $a_{n-1} = -\sigma_1, \dots, a_{n-l} = (-1)^l \sigma_l$ where σ_t is the t^{th} symmetric function in b_1, \dots, b_n ,

$$\sigma_t = \sum_{i_1 < i_2 < \cdots < i_t} b_{i_1} b_{i_2} \cdots b_{i_t}.$$

Let

$$S_t = \sum_{i=1}^n b_i^t.$$

Then σ_t and S_t are linked by Newton's formulae as follows:

$$S_t - \sigma_1 S_{t-1} + \sigma_2 S_{t-2} - \dots + (-1)^{t-1} \sigma_{t-1} S_1 + (-1)^t S_0 \sigma_t = 0$$

for $t = 1, 2, \dots$. Given $S_0 = t \neq 0$ for $t \geq 1$,

$$\sigma_1 = \dots = \sigma_l \quad \text{if and only if} \quad S_1 = \dots = S_l = 0.$$

Now $S_t = \sum_{i=1}^n b_i^t = \sum_{j=1}^l d_j c_j^t$ so that as $\sigma_t = 0$ for $t = 1, 2, \dots, l$,

$$\sum_{j=1}^l d_j c_j^t = 0 \quad \text{for } t = 1, \dots, l.$$

These equations are linear in d_j . Therefore

$$\begin{bmatrix} c_1 & c_2 & \dots & c_l \\ c_1^2 & c_2^2 & \dots & c_l^2 \\ \vdots & & & \vdots \\ c_1^l & c_2^l & \dots & c_l^l \end{bmatrix} \begin{bmatrix} d_1 \\ d_2 \\ \vdots \\ d_l \end{bmatrix} = \begin{bmatrix} 0 \\ 0 \\ \vdots \\ 0 \end{bmatrix}.$$

As none of the $d_j = 0$ for $j = 1, \dots, l$, the coefficient matrix has zero determinant. Hence

$$\begin{aligned} \begin{vmatrix} c_1 & c_2 & \dots & c_l \\ c_1^2 & c_2^2 & \dots & c_l^2 \\ \vdots & & & \vdots \\ c_1^l & c_2^l & \dots & c_l^l \end{vmatrix} &= c_1 c_2 \dots c_l \begin{vmatrix} 1 & 1 & \dots & 1 \\ c_1 & c_2 & \dots & c_l \\ \vdots & & & \vdots \\ c_1^{l-1} & c_2^{l-1} & \dots & c_l^{l-1} \end{vmatrix} \\ &= c_1 c_2 \dots c_l \cdot (\text{Vandermonde determinant}) \\ &= c_1 c_2 \dots c_l \prod_{i < j} (c_i - c_j) \\ &= 0. \end{aligned}$$

As we have exactly l distinct factors, $c_i \neq c_j$ for $i \neq j$ we must have $c_j = 0$ for some j . Without loss of generality assume $c_l = 0$.

Divide w by z^n to obtain \bar{w} . Then

$$\bar{w}(z) = z^{n-l} + a_{n-1} z^{n-l-1} + \dots + a_l = \prod_{j=1}^{l-1} (z - c_j)^{n_j}$$

with $a_{n-1} = \dots = a_{n-l+1} = 0$. By the same reasoning as above we get $c_j = 0$ for some $j < l$. But then $c_j = c_l$ which contradicts our assumption that we have exactly l factors. □

Proof of Theorem 1.2. The proof of (i) is identical to that of Theorem 1.1 because of the following:

- (i) As f is monic in y we can find the first $h - 1$ approximate roots of f , g_0, g_1, \dots, g_{h-1} , as before. That is, as $f \in \mathbb{C}[x, y]$ is monic in y and $\deg_y(f) = p_1 p_2 \cdots p_k \cdots p_h d$ we put $g_0 = x$ and for $k = 1, 2, \dots, h - 1$ there exists a unique polynomial g_k (monic in y) such that

$$f = g_k^{p_k \cdots p_h d} + \zeta_k$$

where $\deg_y(\zeta_k) < p_1 p_2 \cdots p_{k-1}$. Here g_k is the $(p_k \cdots p_h d)^{\text{th}}$ approximate root of f . Then

$$\zeta_k = \sum_{\gamma_0 \cdots \gamma_k} a_{\gamma_0 \cdots \gamma_k} g_0^{\gamma_0} g_1^{\gamma_1} \cdots g_k^{\gamma_k}$$

where $g_0 = x$ and g_1, g_2, \dots, g_{k-1} are the $(p_1 p_2 \cdots p_h d)^{\text{th}}, (p_2 \cdots p_h d)^{\text{th}}, \dots, (p_{k-1} \cdots p_h d)^{\text{th}}$ approximate roots of f respectively. In addition, $0 \leq \gamma_0, 0 \leq \gamma_1 < p_1, \dots, 0 \leq \gamma_{k-1} < p_{k-1}, 0 \leq \gamma_k < p_k \cdots p_h d - 1$.

- (ii) No two of the corner points of $\text{NP}_k(g_k^{p_k \cdots p_h d})$ and $\text{NP}_k(a_{\gamma_0 \cdots \gamma_k} g_0^{\gamma_0} g_1^{\gamma_1} \cdots g_k^{\gamma_k})$ coincide.
- (iii) At each of the first $h - 1$ stages of finding the cabling pairs for the component of the link at infinity at $y = 0$, there just one key line segment in $\text{NP}_k(f)$ that gives just one cabling pair.

Given this we see that all the results of the technical lemmas in section 3.5 and the corresponding results in section 3.6 will carry over for f .

To prove (ii) we first note that if $l = 1$ then Theorem 1.2 is exactly Theorem 1.1. So assume that $l \geq 2$. We start with the case for no redundant cables at the h^{th} stage. Consider the Newton polygon at stage h . For $p_h \geq 2$ it is of the form

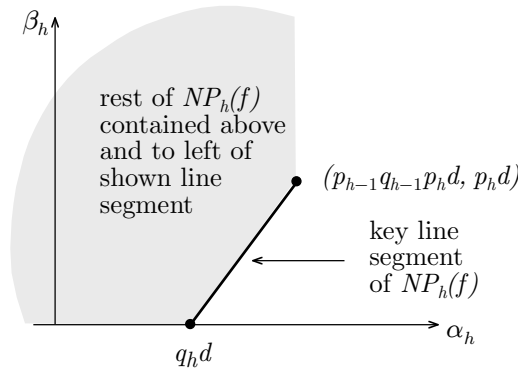

However it is possible that for $p_h = 1$ there may be more than one line segment corresponding to the branches at this node. The boundary of $NP_h(f)$ will still include that part of the line segment marked on the following diagram:

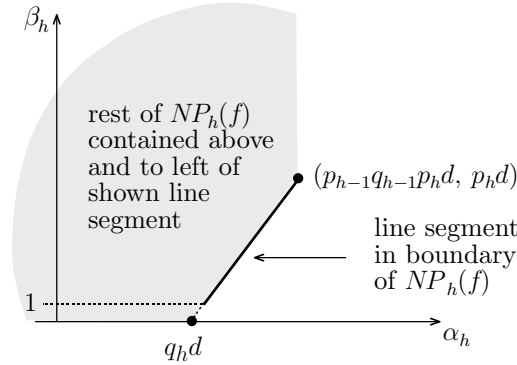

Therefore for $p_h \geq 1$ there is a line segment of slope p_h/τ_h . Thus we can express f_h in the form

$$f_h = \prod_{i=1}^l b_h (y_h^{p_h} - t_{h,i}^{p_h} x_h^{-\tau_h})^{d_i} + \sum_{\alpha_h p_h - \beta_h q_h < q_h d} b_{\alpha_h \beta_h} x_h^{\alpha_h} y_h^{\beta_h}$$

for some $b_h \neq 0, b_{\alpha_h \beta_h} \in \mathbb{C}$, where $t_{h,i}^{p_h} \neq t_{h,j}^{p_h}$ for $i \neq j$. Consider the expansion of the terms in f_h corresponding to the line segment of slope p_h/τ_h :

$$\prod_{i=1}^l b_h (y_h^{p_h} - t_{h,i}^{p_h} x_h^{-\tau_h})^{d_i} = b_h \sum_{r=0}^d c_r x_h^{q_{h-1} p_{h-1} p_h d - r \tau_h} y_h^{p_h d - r p_h}.$$

Denote these terms by $f_{h,seg}$. Note that $c_0 = 1$. As there are l branches, $f_{h,seg}$ must have exactly l distinct factors. Thus from Lemma 4.1, one of $c_1 \cdots c_l \neq 0$. Thus there must be at least one key point in $f_{h,seg}$ for $r = 1, 2, \dots, l$. Following the same reasoning as we used in Lemma 3.26, we conclude that there exists some $a_{\gamma'_0 \dots \gamma'_l} g_0^{\gamma'_0} \cdots g_h^{\gamma'_l}$ with non-zero coefficient such that

$$(p_1 \cdots p_{h-1} \gamma'_0 + q_1 p_2 \cdots p_{h-1} \gamma'_1 + \cdots + q_{h-1} \gamma'_{h-1} + q_{h-1} p_{h-1} \gamma'_h, \gamma'_h) = (q_{h-1} p_{h-1} p_h d - r \tau_h, p_h d - r p_h)$$

for some $r \in \{1, 2, \dots, l\}$. As $\gamma'_h = p_h d - r p_h$,

$$p_1 \cdots p_{h-1} \gamma'_0 + q_1 p_2 \cdots p_{h-1} \gamma'_1 + \cdots + q_{h-1} \gamma'_{h-1} + q_{h-1} p_{h-1} (p_h d - r p_h) = q_{h-1} p_{h-1} p_h d - r \tau_h$$

Hence

$$p_1 \cdots p_{h-1} \gamma'_0 + q_1 p_2 \cdots p_{h-1} \gamma'_1 + \cdots + q_{h-1} \gamma'_{h-1} = q_{h-1} p_{h-1} r p_h - r \tau_h = r q_h.$$

Multiplying both sides by $p_h d$ gives the required result.

The argument for the case of redundant cables is the similar to that used in section 3.6 except that we obtain

$$\gamma'_h = p_h d - r p_h$$

and

$$p_1 \cdots p_{h-1} \gamma'_0 + q_1 p_2 \cdots p_{h-1} \gamma'_1 + \cdots + q_{h-1} \gamma'_{h-1} + s_{h,l_h} \gamma'_h = s_{h,l_h} p_h d - r \tau_h.$$

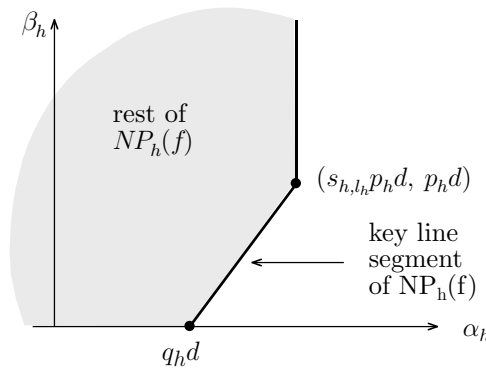

Therefore

$$p_1 \cdots p_{h-1} \gamma'_0 + q_1 p_2 \cdots p_{h-1} \gamma'_1 + \cdots + q_{h-1} \gamma'_{h-1} + s_{h,l_h} (p_h d - r p_h) = s_{h,l_h} p_h d - r \tau_h$$

and

$$p_1 \cdots p_{h-1} \gamma'_0 + q_1 p_2 \cdots p_{h-1} \gamma'_1 + \cdots + q_{h-1} \gamma'_{h-1} = s_{h,l_h} r p_h - r \tau_h = r q_h.$$

Multiply each side by $p_k \cdots p_h$ to obtain

$$\delta_0 \gamma'_0 + \delta_1 \gamma'_1 \cdots \delta_{h-1} \gamma'_{h-1} = r \psi_k.$$

As $\gamma'_i \geq 0$, for all i , the result follows and

$$r \psi_h \in \text{semi-group}\{\delta_0, \dots, \delta_{k-1}\}$$

for some $r \in \{1, 2, \dots, l\}$. □

5. The case with more points at infinity

Theorem 5.1. *Assume Let $f \in \mathbb{C}[x, y]$ be an irreducible polynomial that defines a curve $f(x, y) = 0$ satisfying the following conditions:*

- *The splice diagram is*

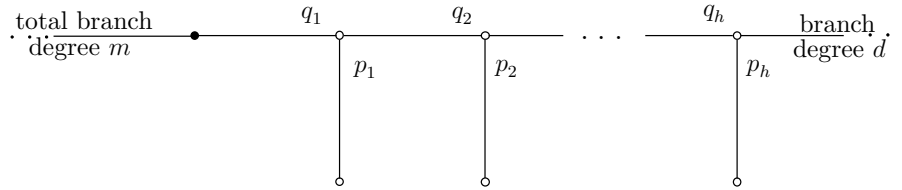

so that the polynomial has either one ($m = 0$) or two ($m > 0$) points at infinity.

- *the section shown with cabling pairs $(p_1, q_1), \dots, (p_h, q_h)$ occurs on the branch corresponding to the point at infinity $y = 0$,*
- *$f = \rho + x^m \xi$ with $\rho, \xi \in \mathbb{C}[x, y]$ so that $x^{-m} f \in \mathbb{C}[x^{-1}, x, y]$ is monic in y ,*
- *$\deg_y(f) = \deg_y(\xi) = p_1 p_2 \dots p_h d$ for some $d \in \mathbb{C}$ and*
- *$\deg_y(\rho) < \deg_y(\xi) - p_1 p_2 \dots p_{h-1} = p_1 p_2 \dots p_h d - p_1 p_2 \dots p_{h-1}$, $\deg_x(\rho) < m$.*

Then, for $j = 1, 2, \dots, h$,

$$m p_1 p_2 \dots p_h d + \psi_j \in \text{semi-group} \{ p_1 p_2 \dots p_h d, q_1 p_2 p_3 \dots p_h d, \dots, q_{j-1} p_j p_{j+1} \dots p_h d \} \cup \{0\}$$

The Abhyankar-Moh semi-group conditions are the case $m = 0$ and $d = 1$.

The condition on the y -degree of ρ ensures, for g_k the $(p_k \dots p_h)^{\text{th}}$ root of $x^{-m} f$, that $x^m g_k^{p_k \dots p_h d}$ is a polynomial and that $\text{NP}(x^m g_k^{p_k \dots p_h d})$ lies inside $\text{NP}(f)$ for $k = 1, \dots, h$. It is in fact sufficient that $\zeta_k = f - x^m g_k^{p_k \dots p_h d}$ is such that $\deg_y(\zeta_k) < p_1 \dots p_h d - p_1 \dots p_{k-1}$ for all k . Given the above we have $\deg_x(f) = q_1 p_2 \dots p_h d + m$ and $q_1 < p_1$, and that $\text{NP}(f)$ is as follows:

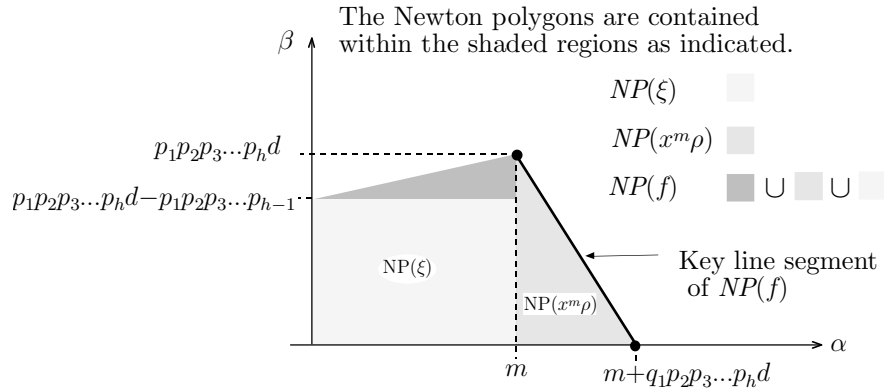

The link at infinity has two parts, that part that is found at $y = 0$ and that at $x = 0$. The branch under consideration corresponds to $y = 0$. Let L_y be the union of the components of the link at infinity at $y = 0$. We then name the vertices in the diagram corresponding to the branch $y = 0$ in the same way as in section 4. We again let S_{u_i} and S_{v_i} denote the virtual components of the link corresponding to the nodes $\{u_i\}_{i=0}^h$ and $\{v_j\}_{j=1}^h$ respectively. We name the linking numbers of the virtual components with L_y by

$$\begin{aligned} \delta_0 = l_{u_0} &= \text{link}(S_{u_0}, L_y) = p_1 p_2 \cdots p_h d \\ \delta_1 = l_{u_1} &= \text{link}(S_{u_1}, L_y) = q_1 p_2 p_3 \cdots p_h d \\ \delta_2 = l_{u_2} &= \text{link}(S_{u_2}, L_y) = q_2 p_3 p_4 \cdots p_h d \\ &\vdots \\ \delta_h = l_{u_h} &= \text{link}(S_{u_h}, L_y) = q_h d \end{aligned}$$

and

$$\begin{aligned} \psi_1 = l_{v_1} &= \text{link}(S_{v_1}, L_y) = q_1 p_1 p_2 \cdots p_h d \\ \psi_2 = l_{v_2} &= \text{link}(S_{v_2}, L_y) = q_2 p_2 p_3 \cdots p_h d \\ &\vdots \\ \psi_h = l_{v_h} &= \text{link}(S_{v_h}, L_y) = q_h p_h d \end{aligned}$$

If $m \geq 1$, the curve has two points at infinity and the link at infinity has two or more components. The points at infinity for a curve $f(x, y) = 0$ are the points of intersection of the closure of $f(x, y) = 0$ in $\mathbb{C}P^2$ with the line at infinity $\mathbb{C}P^1$.

In the case that $q_{k-1} \leq 0$ so that $q_k < 0$, the above semi-group conditions do not restrict the value of q_k in any further way.

Let $g = x^{-m} f = x^{-m} \rho + \xi$. We note the following:

- (i) As g is monic in y we can find approximate roots of g, g_0, g_1, \dots, g_h , as before. The condition $\deg_y(\rho) < p_1 p_2 \cdots p_h d - p_1 p_2 \cdots p_{h-1}$ means that g_1, \dots, g_h are the approximate roots of ξ so that $x^m g_k^{p_k \cdots p_h d}$, $k = 1, \dots, h$ are all polynomials. Then

$$g = g_k^{p_k \cdots p_h d} + \zeta_k$$

where $\zeta_k \in \mathbb{C}[x, x^{-1}, y]$ with $\deg_x(\zeta_k) \geq -m$ and $\deg_y(\zeta_k) < p_1 \cdots p_h d - p_1 \cdots p_{k-1}$. As before

$$\zeta_k = \sum a_{\gamma_0 \dots \gamma_k} g_0^{\gamma_0} \cdots g_k^{\gamma_k}$$

where $0 \leq \gamma_1 < p_1, \dots, 0 \leq \gamma_{k-1} < p_{k-1}, 0 \leq \gamma_k < p_k \cdots p_h d - 1$. However, γ_0 is no longer a non-negative integer. It now satisfies the condition $\gamma_0 \geq -m$.

- (ii) The uniqueness of the corner points of the terms of g still holds as the Lemmas 3.22 and 3.23 did not depend upon γ_0 and γ'_0 or any q_i being positive.
- (iii) At each of the first h stages of finding the cabling pairs for the component of link at infinity at $y = 0$, there is a key line segment in $NP_k(g)$ and this gives just one branch in the splice diagram.

Given this we see that all the results of the technical lemmas in section 3.5 and the corresponding results in section 3.6 will carry over for g .

As the k^{th} Newton polygon of x is a point on the α_k -axis, the effect of multiplying g by x^m is to translate each Newton polygon to the right by a multiple of m . In addition, we see that the equations used to find the first h Newton pairs of f and g will be the same except of a factor $x^{c_k m}$ for some constant c_k at each stage. Thus the first h Newton pairs of f and g will be identical.

Proof of Theorem 5.1. Using the same logic as in the proof of Theorem 1.1 we again find that the result is clear for $k = 1$ as

$$\psi_1 = q_1 p_1 \cdots p_h d$$

and

$$\delta_0 = p_1 \cdots p_h d$$

so that $q_1 \geq 0$,

$$m p_1 \cdots p_h d + \psi_1 \in \text{semi-group}\{\delta_0\} \cup \{0\}.$$

From the above discussion we note that the assumptions used in the proof of Theorem 1.1 hold for g . Where there are no redundant Newton pairs these are:

- (i) that the terms of g with non-zero coefficients have Newton polygons with corner points occurring at (α_k, β_k) where

$$\begin{aligned} \alpha_k &= p_1 \cdots p_{k-1} \gamma_0 + q_1 p_2 \cdots p_{k-1} \gamma_1 + \cdots + q_{k-1} \gamma_{k-1} + q_{k-1} p_{k-1} \gamma_k, \\ \beta_k &= \gamma_k, \end{aligned}$$

(ii) that there is some term in g

$$a_{\gamma'_0 \dots \gamma'_k} g_0^{\gamma'_0} \dots g_k^{\gamma'_k}$$

$a_{\gamma'_0 \dots \gamma'_k} \neq 0$ whose Newton polygon $\text{NP}_k(a_{\gamma'_0 \dots \gamma'_k} g_0^{\gamma'_0} g_1^{\gamma'_1} \dots g_k^{\gamma'_k})$ has corner point at the key point on the boundary of $\text{NP}_k(g)$, (α_k, β_k) with

$$\begin{aligned} \alpha_k &= q_{k-1} p_{k-1} p_k \dots p_h d - \tau_k, \\ \beta_k &= p_k \dots p_h d - p_k, \end{aligned}$$

where $q_k = q_{k-1} p_{k-1} p_k - \tau_k$.

We then have

$$\gamma'_k = p_k \dots p_h d - p_k$$

and

$$\begin{aligned} p_1 \dots p_{k-1} \gamma'_0 + q_1 p_2 \dots p_{k-1} \gamma'_1 + \dots + q_{k-1} \gamma'_{k-1} + q_{k-1} p_{k-1} \gamma'_k \\ = q_{k-1} p_{k-1} p_k \dots p_h d - \tau_k. \end{aligned}$$

Therefore

$$\begin{aligned} p_1 \dots p_{k-1} \gamma'_0 + q_1 p_2 \dots p_{k-1} \gamma'_1 + \dots + q_{k-1} \gamma'_{k-1} + q_{k-1} p_{k-1} (p_k \dots p_h d - p_k) \\ = q_{k-1} p_{k-1} p_k \dots p_h d - \tau_k \end{aligned}$$

and thus

$$p_1 \dots p_{k-1} \gamma'_0 + q_1 p_2 \dots p_{k-1} \gamma'_1 + \dots + q_{k-1} \gamma'_{k-1} = q_{k-1} p_{k-1} p_k - \tau_k = q_k.$$

Multiply each side by $p_k \dots p_h d$ to obtain

$$\delta_0 \gamma'_0 + \delta_1 \gamma'_1 \dots \delta_{k-1} \gamma'_{k-1} = \psi_k.$$

We have $\gamma'_i \geq 0$, for $i = 1, \dots, k$ and $\gamma_0 \geq -m$. To ensure that δ_0 has a non-negative coefficient add $m\delta_0$ to each side to obtain

$$\delta_0(m + \gamma'_0) + \delta_1 \gamma'_1 \dots \delta_{k-1} \gamma'_{k-1} = \delta_0 m + \psi_k$$

which is the required result as $\delta_0 = p_1 \dots p_h d$. Note, it is possible that $\text{gcd}(p_k, q_k) = 1$ while $\text{gcd}(p_k, mp_1 \dots p_{k-1} + q_k) \neq 1$ so that we may have $mp_1 \dots p_{k-1} + q_k = 0$. Thus

$$mp_1 \dots p_h d + \psi_k \in \text{semi-group}\{\delta_0, \dots, \delta_{k-1}\} \cup \{0\}.$$

To prove Theorem 5.1 in the case where there are redundant Newton pairs one can use the same techniques as in section 3.6. □

Acknowledgement. I wish to thank Walter Neumann for introducing me to an exciting and stimulating area of mathematics and for his help and encouragement.

References

- [1] S. S. Abhyankar, *Lectures on expansion techniques in algebraic geometry*, with notes by B. Singh, Tata Institute of Fundamental Research Lectures on Mathematics and Physics, vol. 57, Tata Institute of Fundamental Research, Bombay, 1977.
- [2] ———, *Algebraic geometry for scientists and engineers*, Mathematical Surveys and Monographs, vol. 35, American Mathematical Society, Providence, RI, 1990.
- [3] S. S. Abhyankar and T. T. Moh, *Newton-Puiseux expansion and generalized Tschirnhausen transformation. I*, J. Reine Angew. Math. **260** (1973), 47–83.
- [4] ———, *Embeddings of the line in the plane*, J. Reine Angew. Math. **276** (1975), 148–166.
- [5] N. A'Campo and M. Oka, *Geometry of plane curves via Tschirnhausen resolution tower*, Osaka J. Math. **33** (1996), no. 4, 1003–1033.
- [6] E. Artal-Bartolo, *Une démonstration géométrique du théorème d'Abhyankar-Moh*, J. Reine Angew. Math. **464** (1995), 97–108.
- [7] E. Artal-Bartolo, P. Cassou-Noguès, and A. Dimca, *Sur la topologie des polynômes complexes*, Singularities (Oberwolfach, 1996), Progr. Math., vol. 162, Birkhäuser, Basel, 1998, pp. 317–343.
- [8] E. Artal-Bartolo, P. Cassou-Noguès, and I. Luengo Velasco, *On polynomials whose fibers are irreducible with no critical points*, Math. Ann. **299** (1994), no. 3, 477–490.
- [9] E. Brieskorn and H. Knörrer, *Plane algebraic curves*, translated by J. Stillwell, Birkhäuser Verlag, Basel, 1986.
- [10] P. Cassou-Noguès, *Entrelacs toriques itérés et intégrales associées à une courbe plane*, Sémin. Théor. Nombres Bordeaux (2) **2** (1990), no. 2, 273–331.
- [11] ———, *The effect of rational maps on polynomial maps*, Ann. Polon. Math. **76** (2001), no. 1-2, 21–31.
- [12] D. Eisenbud and W. Neumann, *Three-dimensional link theory and invariants of plane curve singularities*, Annals of Mathematics Studies, vol. 110, Princeton University Press, Princeton, NJ, 1985.
- [13] F. Kirwan, *Complex algebraic curves*, London Mathematical Society Student Texts, vol. 23, Cambridge University Press, Cambridge, 1992.
- [14] S. Lefschetz, *Algebraic geometry*, Princeton University Press, Princeton, N. J., 1953.
- [15] J. Milnor, *Singular points of complex hypersurfaces*, Annals of Mathematics Studies, No. 61, Princeton University Press, Princeton, N.J., 1968.
- [16] M. Miyanishi, *Minimization of the embeddings of the curves into the affine plane*, J. Math. Kyoto Univ. **36** (1996), no. 2, 311–329.
- [17] Y. Nakazawa and M. Oka, *Smooth plane curves with one place at infinity*, J. Math. Soc. Japan **49** (1997), no. 4, 663–687.
- [18] W. D. Neumann, *Complex algebraic plane curves via their links at infinity*, Invent. Math. **98** (1989), no. 3, 445–489.
- [19] ———, *Irregular links at infinity of complex affine plane curves*, Quart. J. Math. Oxford Ser. (2) **50** (1999), no. 199, 301–320.

- [20] W. D. Neumann and P. G. Wightwick, *Algorithms for polynomials in two variables*, Combinatorial and computational algebra (Hong Kong, 1999), Contemp. Math., vol. 264, Amer. Math. Soc., Providence, RI, 2000, pp. 219–235.
- [21] I. Newton, *Curves by Sir Isaac Newton*, Lexicum technicum: An universal dictionary or arts and sciences. Vol. II (J. Harris, ed.), London, 1710; reprinted in *The mathematical works of Isaac Newton*. Vol. II, with an introduction by D. T. Whiteside, Johnson Reprint Corp., New York, 1967, pp. 135–161.
- [22] H. Pinkham, *Courbe planes ayant une seule place à l'infini*, Séminaire sur les Singularités des Surfaces (Centre de Mathématiques de l'École Polytechnique, Palaiseau, 1977–1978).
- [23] M. Puiseux, *Recherches sur les fonctions algébriques*, Journal de Math. (1) **15** (1850), 365–480.
- [24] A. Sathaye, *Degree-semigroups of plane algebraic curves*, preprint.
- [25] A. Sathaye and J. Stenerson, *Plane polynomial curves*, Algebraic geometry and its applications (West Lafayette, IN, 1990), Springer, New York, 1994, pp. 121–142.
- [26] A. Schinzel, *Polynomials with special regard to reducibility*, with an appendix by U. Zannier, Encyclopedia of Mathematics and its Applications, vol. 77, Cambridge University Press, Cambridge, 2000.
- [27] M. Suzuki, *Propriétés topologiques des polynômes de deux variables complexes, et automorphismes algébriques de l'espace \mathbf{C}^2* , J. Math. Soc. Japan **26** (1974), 241–257.
- [28] ———, *Affine plane curves with one place at infinity*, Ann. Inst. Fourier (Grenoble) **49** (1999), no. 2, 375–404.
- [29] E. W. von Tschirnhausen, *Acta eruditorum*, Leipzig, 1683.
- [30] R. J. Walker, *Algebraic curves*, Dover Publications Inc., New York, 1962.
- [31] P. G. Wightwick, *Algebraic curves and their links*, Minor Masters Thesis, University of Melbourne, 1995.
- [32] ———, *Equivalence of polynomials under automorphisms of \mathbf{C}^2* , J. Pure Appl. Algebra **157** (2001), no. 2-3, 341–367.
- [33] M. G. Zaïdenberg and V. Ya. Lin, *An irreducible, simply connected algebraic curve in \mathbf{C}^2 is equivalent to a quasihomogeneous curve*, Dokl. Akad. Nauk SSSR **271** (1983), no. 5, 1048–1052 (Russian).