

REVISTA MATEMÁTICA de la
Universidad Complutense de Madrid
Volumen 10, número Suplementario: 1997

Classification of obstructions for separation of semialgebraic sets in dimension 3^\dagger .

F. ACQUISTAPACE*, C. ANDRADAS# and F. BROGLIA*

Abstract

Applying general results on separation of semialgebraic sets and spaces of orderings, we produce a catalogue of all possible geometric obstructions for separation of 3-dimensional semialgebraic sets and give some hints on how separation can be made decidable.

Introduction

In the last years different applications have shown the theory of spaces of orderings to be a very useful tool for the study of semialgebraic sets. Probably the best well known of them is the application of spaces of orderings to the question of determining the minimal number of functions needed to describe semialgebraic sets, see [Brö3], [Sch], [AnBröRz]. Another very important instance, which is our main concern in this note, has to do with the problem of separation of semialgebraic sets. In both cases the basic idea behind the scenes is that the theory of spaces of orderings allows to translate the geometrical problem into a combinatorial one, since it reduces the question to deal with a finite space and a finite number of functions.

†This work is partially supported by European Community contract CHRX-CT94-0506.

*Members of G.N.S.A.G.A. of C.N.R.

The authors are partially supported by M.U.R.S.T.

#Partially supported by DGICYT, PB 92-0498-C02-02 and Fundación del Amo, UCM.

Mathematics Subject Classification: 14P10

Servicio Publicaciones Univ. Complutense. Madrid, 1997.

In particular, Bröcker's characterization of separation (see [Brö2]) roughly states that two semialgebraic sets A, B in an algebraic variety M cannot be separated by a polynomial if and only if there exists a finite subspace X of the space of orderings of the field K of rational functions of M , in which A and B cannot be separated. Moreover it gives an upper bound for the chain length of that subspace so that we actually have an upper bound for the number of elements of X . Since the number of isomorphism classes of finite spaces of orderings with bounded chain length and stability index is finite, we can even list (up to isomorphism) all the spaces that must be tested in order to conclude whether the separation of A and B is possible.

However, still an infinite number of subspaces exist for each isomorphism class and, also, spaces of orderings can be quite weird objects, so that the question of deciding whether A and B can be separated is, at this point, far away from being decidable.

On the other hand, in [AcBgFo], without any reference to spaces of orderings, there is a geometric criterion that characterizes the separation of A and B when $\dim M = 3$, in terms of the separation of their traces or shadows on the walls (i.e., the irreducible components of the common boundary) of A and B . This strongly suggests the possibility of working recursively, lowering the dimension, so that one could give an algorithmic answer to the separation problem.

The aim of this paper is to conciliate both approaches. On the one hand we will show how to use the theory of spaces of orderings to prove the quoted geometric criterion, as well as illustrate the geometry carried by (or behind of) the spaces of orderings. On the other hand, closing the loop, we will show how, in case A and B cannot be separated, the geometric criterion produces finite spaces of orderings in which separation already fails. Thus we will produce a catalogue of all geometric configurations that obstruct separation in three dimensional spaces.

The key point to extract geometric information from abstract spaces of orderings is to consider a special class of them, which we call *geometric*. Roughly speaking, these are spaces of orderings associated to discrete valuations of K and therefore, after possibly blowing-up M , they are centered at geometric subvarieties. Moreover, geometric spaces of orderings turn out to be dense among all spaces of orderings, so that whatever we can decide by means of abstract spaces of orderings we can

also decide by geometric ones.

One main purpose of this work is to be enlightening, specially for those not familiar with spaces of orderings. That is the reason why we restrict ourselves to dimension three, where geometrical intuition works and pictures can be drawn. We also skip some proofs (which are often rather complicated and technical) which will appear for arbitrary dimension in the forthcoming paper [AcAnBg]. In section 1 we recall briefly the notions of spaces of orderings required to understand the paper, intending to be as much down-to-earth as one can possibly be. In section 2 we prove the equivalence between Bröcker's separation result in terms of spaces of orderings and the geometric criterion of [AcBgFo]. Finally, in section 3 we produce the announced catalogue of configurations that give rise to non-separable semialgebraic sets.

1 Geometric spaces of orderings: some recalls and definitions

Let K be a finitely generated extension of \mathbf{R} of transcendence degree n , that is, K is the field of rational functions $K(M)$ of some irreducible real algebraic variety M with $\dim M = n$. We denote by $\text{Spec}_r K$ the real spectrum of K , i.e., the space of orderings of K .

Given $E \subset K^*$ and $Y \subset \text{Spec}_r K$, one can define

$$E^\perp = \{\sigma \in \text{Spec}_r K \mid f(\sigma) > 0, \forall f \in E\}$$

$$Y^\perp = \{f \in K^* \mid f(\sigma) > 0, \forall \sigma \in Y\} = \bigcap_{\sigma \in Y} \sigma$$

if we identify σ with the cone of its positive elements. A subset $Y \subset \text{Spec}_r K$ is called a *subspace* if it verifies $Y^{\perp\perp} = Y$.

If we identify an ordering of $\text{Spec}_r K$ with the element of $\hat{G} = \text{Hom}(G, \mathbf{Z}_2)$ which sends each function to its sign, $\text{Spec}_r K$ becomes an abstract space of orderings in the sense of [Ma] (see also [AnBröRz]) by considering the couple $(\text{Spec}_r K, G)$ where $G = K^*/\Sigma$, and Σ represents the set of sums of squares of K . Of course, a subspace Y of $\text{Spec}_r K$ is also a subspace in the sense of [Ma], namely, $(Y, G/Y^\perp)$.

Examples 1.1. Any singleton $E = \{\sigma\}$, σ being an ordering, is a subspace which is called *atomic*. A set of 3 orderings $\{\sigma_1, \sigma_2, \sigma_3\}$ is

a subspace if and only if the product $\sigma_1\sigma_2\sigma_3$ is not an ordering of K (which is mainly the case). If $\sigma_4 = \sigma_1\sigma_2\sigma_3$ happens to be an ordering then $\{\sigma_1, \sigma_2, \sigma_3, \sigma_4\}$ is a finite subspace (in fact the subspace spanned by $\sigma_1, \sigma_2, \sigma_3$) which is called a *4-element fan*. More generally a finite fan F is a finite subset such that $F^3 \subset F$. Fans are very special subspaces.

Two operations are defined between abstract spaces of orderings to build new ones.

- (1) *the sum*: $(Y_1, G_1) + (Y_2, G_2) = (Y, G)$, where Y is the disjoint union of Y_1 and Y_2 , $G = G_1 \times G_2$ and Y acts on G by

$$\sigma(g_1, g_2) = \begin{cases} \sigma(g_1) & \text{if } \sigma \in Y_1 \\ \sigma(g_2) & \text{if } \sigma \in Y_2 \end{cases}$$

- (2) *the extension*: if H is a group which is a \mathbf{Z}_2 -module the extension is defined as $(X', G)[H] = (X' \times \hat{H}, G \times H)$ where $\hat{H} = \text{Hom}(H, \mathbf{Z}_2)$ and $(\sigma, \hat{h})(g, h) = \sigma(g) \cdot \hat{h}(h)$

In the context of the space $\text{Spec}_r K$ of orderings of a field, the addition corresponds to the union of disjoint "independent" families X_1, X_2 of orderings of K in the sense that $(X_1)^\perp \cdot (X_2)^\perp = K^*$. Extension corresponds to consider the family of orderings compatible with a real valuation and specializing to a given subspace X' of the residue field. This is also called the pull-back of X' . Following this idea, if $X = X'[H]$ is an extension and $\sigma = (\sigma', \hat{h}) \in X$, $\sigma' \in X'$, $\hat{h} \in \hat{H}$, we will say that σ specializes to σ' , and we will refer to the fiber $\{\sigma'\} \times \hat{H}$ as the set of *generizations* of σ' .

Now, the following fundamental theorem explains the structure of finite spaces of orderings in terms of the operations just described.

Theorem 1.2. (Marshall, see [Ma], [AnBrörRz, Theorem IV.5.1]) *Any finite space of orderings can be built in a unique way (up to isomorphism) by a finite sequence of sums and extensions, starting from a finite number of atomic spaces.*

Thus, to any finite space of orderings, we may attach a *weighted tree*, constructed as follows.

- (1) The bottom points of the tree (i.e. points not connected to any lower point) represent atomic spaces.

- (2) The sum $X_1 + X_2$ is represented by the upper point of the tree with two branches whose lower points stand for X_1 and X_2 .

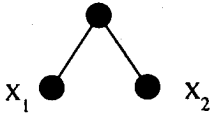

- (3) The extension $X[\mathbb{Z}_2^m]$ is represented by the upper point of the tree consisting of a vertical edge with weight m over the point representing X ; if $m = 1$, m is omitted.

Thus, for instance, the tree

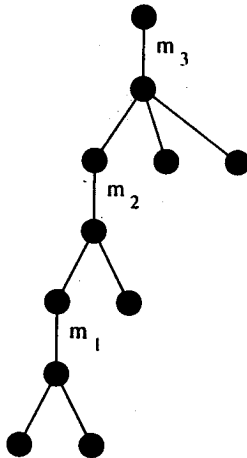

corresponds to the space

$$(((2E[\mathbb{Z}_2^{m_1}] + E)[\mathbb{Z}_2^{m_2}] + 2E)[\mathbb{Z}_2^{m_3}]$$

To any finite space X there are associated two invariants which can be read directly from its tree:

- (1) the *stability index* $s(X)$, which is the maximum of the sum of weights along a path joining a bottom vertex to the top vertex plus 1;

- (2) the *chain length*, which is the number of bottom points.

The key point about considering the trees of finite spaces of orderings is that they allow us to work (either to define properties or to prove them) by induction along the tree. The notion of *geometric spaces of orderings* (GSO for short in the sequel), which is at the core of this paper, is a nice example of it.

Definition 1.3. Let (X, G) be a finite subspace of $\text{Spec}_r K$. We say that it is *geometric* (or GSO for short) if:

- (1) X is atomic, say $X = \{\alpha\}$, and the convex hull W_α of \mathbf{R} with respect to α is a discrete valuation ring of rank n (remember that $\dim M = n$); or
- (2) X is a sum $(X, G) = (X_1, G_1) + (X_2, G_2)$ and both (X_1, G_1) and (X_2, G_2) are geometric; or
- (3) X is an extension $(X, G) = (X_1, G_1)[H]$ of weight a and there is a discrete valuation ring V of K of rank a (hence its residue field k_V is a finitely generated extension of \mathbf{R} of dimension $n - a$), such that (X_1, G_1) is a geometric subspace of $\text{Spec}_r k_V$ and (X, G) is the pull-back of (X_1, G_1) by V .

For instance, a fan $F \subset \text{Spec}_r K$ is geometric if and only if, according to the definition in [AnRz], it is centered at a real prime divisor.

Assume that $X = X'[H]$ is a geometric space of orderings and let V be the valuation associated to the extension so that X' is a geometric space of orderings of the residue field k_V . We can talk about the *center of X in M* as the center of V , that is, the zero set M' of the prime ideal $\mathfrak{p} = \mathcal{R}(M) \cap \mathfrak{M}_V$, where $\mathcal{R}(M)$ is the ring of regular functions on M and \mathfrak{M}_V is the maximal ideal of V . In particular M' has dimension less than or equal to the transcendence degree of k_V , and X' induces (by restriction) a space of orderings on M' , which may be smaller than X' .

In general, if we denote by \mathcal{B}_X the family of all valuation rings of K compatible with some element of a geometric space of orderings X , it follows from the definition that all the valuations of \mathcal{B}_X are discrete and with finitely generated residue field. Note that the definition of GSO is given in terms of valuations and therefore it might happen that a GSO is not realized in a particular model M . To be more precise, we say that

a geometric subspace of orderings X is *realized* in an open semialgebraic subset S of a model M of K if any $\sigma \in X$ specializes in $\text{Spec}_r \mathcal{R}(M)$ through a chain of length n : $\sigma = \sigma^{(0)} \rightarrow \sigma^{(1)} \rightarrow \dots \rightarrow \sigma^{(n)} = \{x\} \in S$. We have:

Proposition 1.4.

- (a) *Any finite space of orderings of stability index s is isomorphic to a geometric subspace realized in an open semialgebraic subset S of dimension s of a model M of K .*
- (b) *Let X be a geometric space of orderings of K . Then there is a compact model of K in which X is realized. Moreover, for any compact model M of K there is a sequence of blowings-up of M , $M_r \rightarrow M_{r-1} \rightarrow \dots \rightarrow M_0 = M$, such that X is realized in M_r .*

Proof. Part (a) is [Brö1, Proposition 3.3]. For part (b) it is enough to blow up M till a model in which all valuations (which are a finite number) of \mathcal{B}_X have a center of dimension equal to the dimension of their residue field.

■

We consider the Harrison topology on the space $\text{Spec}_r K$, i.e., the topology generated by the sets $U(f) = \{\alpha \in \text{Spec}_r K; f >_\alpha 0\}$, where $f \in K$.

In a similar way as discrete valuation rings are proved to be dense in the set of all valuations, we have the following density result for GSOs.

Theorem 1.5. *Let K be a function field of dimension n and M a compact model of K . Let $X \subset \text{Spec}_r K$ be a finite subspace with s elements. Then X can be arbitrarily approximated in the Harrison topology of $(\text{Spec}_r K)^s$ by a geometric subspace isomorphic to X .*

■

Proof. [AcAnBg].

In other words, given a finite space of orderings $X = \{\sigma_1, \dots, \sigma_k\}$ and functions f_{ij} such that for each i , $f_{ij}(\sigma_i) > 0$, we can always find a GSO $Y = \{\tau_1, \dots, \tau_k\}$ isomorphic to X and such that $f_{ij}(\tau_i) > 0$ for each i . Roughly speaking, this implies that GSOs form a distinguished

subclass of spaces of orderings that suffices to check properties defined in terms of the whole collection of spaces of orderings and involving only finitely many polynomials. This is the case for separation as we will see below.

2 Spaces of Orderings and separation of Semi-algebraic Sets

Now, fix a compact non-singular model M of K . Remember that we have a tilde map which assigns to any semialgebraic set $S \subset M$ the constructible subset $\tilde{S} \subset \text{Spec}_r K$ defined by the same equations as S . Two semialgebraic sets have the same tilde image if and only if they are generically equal, i.e. they are equal up to a subset of codimension at least one, [BoCoRy, Proposition 7.6.3]. Thus the study of constructible subsets of $\text{Spec}_r K$ translates into generic properties of semialgebraic sets, that is, what happens up to a set of smaller dimension.

Now, let A, B be disjoint open semialgebraic sets in M . For simplicity, whenever no confusion is possible, we shall denote also by A and B their tilde images in $\text{Spec}_r K$.

We say that A and B are *generically separable* if there exist a proper algebraic subset $Y \subset M$ and a regular function $f \in \mathcal{R}(M)$ such that

$$f(A \setminus Y) > 0 \quad \text{and} \quad f(B \setminus Y) < 0.$$

We say that A and B are *separable* if we can chose Y to be the set

$$\overline{A \cap B}^Z$$

i.e., the smallest set it can be.

Now, a remarkable theorem of Bröcker ([Brö2], [AnBröRz] Theorem IV.7.12) states that A and B are generically separable if and only if their tildes are separable in all finite subspaces of orderings (with chain length bounded, see below) of $\text{Spec}_r K$. Using the density Theorem 1.5, this result can be rewritten using only geometric spaces of orderings as follows:

Theorem 2.1. *A and B are generically separable in M if and only if for every geometric subspace of orderings $X \subset \text{Spec}_r K$ of chain-length $\leq 2^{n-1}$, $A \cap X$ and $B \cap X$ are separable in X .*

Since any subspace of $\text{Spec}_r K$ has stability index $\leq n$, there are only a finite number of isomorphism types of spaces to be tested.

(2.2) Walls. Now, we are interested in the possibility of testing the separation in terms of the boundaries of A and B . To that end, we define the *walls* of A and B as the irreducible $(n-1)$ -dimensional components of the Zariski closure $\overline{\partial A}^Z \cup \overline{\partial B}^Z$ of the boundary of A and B . From now on we assume that *all the walls of A and B are normal crossing and non-singular* (which can always be achieved by desingularization). Under this assumption separation and generic separation coincide.

Then, the main idea here is that A and B can be separated if and only if they can be separated in a neighbourhood of each wall. This can be seen from a pure geometric point of view by means of Lojasiewicz's inequality (see [AcBgFo]), or as an application of Theorem 1.5 above. Indeed, suppose that A and B cannot be separated. Then, there exists a finite geometric space of orderings X in which A and B cannot be separated. Take it with $\#(X)$ minimal. Then, taking into account that if $X = X_1 + X_2$ then A and B can be separated in X if and only if they can be separated in X_1 and X_2 , the minimality hypothesis implies that X is an extension $X = X'[\mathbb{Z}_2]$ and we may assume (up to some blowings-up) that X is centered at a hypersurface W (in other words, X' is a GSO of W).

We claim that W is a wall. For let A', B' be the set of specializations of A and B to X' . First note that A' and B' cannot be separated, since otherwise A and B could be separated in X . Now, if W is not a wall then for any $\sigma' \in A' \cup B'$ the two generizations of σ' in X would lie both either in A or B . But then $X' \times \{1\}$, where we write $\hat{\mathbb{Z}}_2 = \{1, i\}$, is a subspace of X in which A and B cannot be separated (since the projection defines an isomorphism onto X' taking A and B to A' and B' respectively). This contradicts the minimality of X and we are done.

(2.3) Shadows and counter-shadows. Next we want to characterize the separation of A and B in terms of their *shadows* on the walls. To be precise, we define the *shadows* of A and B on a wall W as the sets $\text{Int}(\overline{A} \cap W)$ and $\text{Int}(\overline{B} \cap W)$. Note that if $X = X'[\mathbb{Z}_2]$ is a GSO centered at a wall W , the shadows of A and B correspond to the specializations A' and B' of A and B , respectively, in X' . As explained above, if all the shadows can be separated, then A and B can be separated. However the converse is not true as the following simple example shows: take

$A = \{z > 0, y + 1 > 0\}$ and $B = \{z < 0, 1 - y > 0\}$. Their shadows in $z = 0$ cannot be separated, but the function z separates A from B . To control this phenomenon we introduce the following device: for each wall W consider a polynomial g_W which changes its sign across W , for instance a generator of the ideal $\mathcal{I}(W)\mathcal{R}(M)_{\mathcal{I}(W)}$, and consider the semialgebraic sets

$$\begin{aligned} A_{g_W} &= (A \cap \{g_W > 0\}) \cup (B \cap \{g_W < 0\}) \\ B_{g_W} &= (A \cap \{g_W < 0\}) \cup (B \cap \{g_W > 0\}) \end{aligned}$$

It is easy to verify that A and B are generically separated if and only if the same is true for A_{g_W} and B_{g_W} . Thus, we define the *counter-shadows* of A and B in W as the shadows of the sets A_{g_W} and B_{g_W} .

The corresponding notion in the context of geometric spaces of orderings of the form $X = X'[\mathbb{Z}_2]$ can be defined by taking as counter-shadows the specializations to X' of the sets:

$$\begin{aligned} A^* &= (A \cap (X' \times \{1\})) \cup (B \cap (X' \times \{i\})) \\ B^* &= (A \cap (X' \times \{i\})) \cup (B \cap (X' \times \{1\})) \end{aligned}$$

The nice thing about the counter-shadows is that one can prove that A and B are separable in $X = X'[\mathbb{Z}_2]$ if and only if either their shadows or their counter-shadows are separable in X' . In particular, if A and B are open disjoint semialgebraic subsets of M and W is a wall, their tildes \tilde{A} and \tilde{B} are not separated in $X'[\mathbb{Z}_2]$, $X' = \text{Spec}_\tau K(W)$, if and only if neither the shadows nor the counter-shadows of A and B in W are separable. This yields to the following result:

Theorem 2.4. (Separation criterion) *Let A and B be as above: $Y = \overline{\partial A}^Z \cup \overline{\partial B}^Z$ has non-singular irreducible components which are normal crossings. Then A and B can be separated if, and only if, for every wall $W \subset Y$ either the shadows or the counter-shadows of A and B are separable in W .*

Proof. A purely geometric proof in dimension 3 can be found in [AcBgFo]. Here we just outline the proof of the general case, which will appear in [AcAnBg]. Assume that A and B are not separable. Then, by Theorem 2.1, we find a finite GSO X in which A and B cannot be separated. Moreover, if we take $\#(X)$ minimal we may assume

that $X = X'[\mathbb{Z}_2]$ and X' is a GSO at some wall W' , possibly after some blowings-up. Now, neither the shadows nor the counter-shadows of A and B are separable in X' , which implies that neither the shadows nor the counter-shadows of A and B in W are separable. Finally, since the walls were already at normal crossings, we can trace back the blowings-up to get an original wall W where also neither the shadows nor the counter-shadows are separable.

Conversely, if W is a wall in which neither the shadows nor the counter-shadows are separable then A and B are not separable in $X'[\mathbb{Z}_2]$, $X' = \text{Spec}_r K(W)$, which in particular implies that A and B are not separable.

■

Remark 2.5. In the next section we will see how to construct explicitly, from a wall in which the separation criterion fails, a GSO in which the separation of A and B is not possible.

As a consequence of the separation criterion we get

Theorem 2.6. *The separation problem is decidable.*

Proof. Again we refer to [AcAnBg] for a complete proof. The main ideas behind are: given A and B , first desingularize the walls to make them normal crossings (this can be done in a constructive way, see [BiMi]); then apply the criterion to lower the dimension. After a finite number of steps we are in dimension 1 where two open semialgebraic sets are separable if and only if they are disjoint. Also, one can stop in dimension 2 and apply the arguments and algorithms in [AcBgVe] and [Ve].

■

3 Catalogue of 3-dimensional non-separable configurations

In this section we will apply the above results to produce a catalogue of all configurations that make impossible the separation of two open semialgebraic subsets of a non-singular 3-dimensional variety.

Let A and B be two open disjoint semialgebraic subsets of M , $\dim M = 3$. We assume M to be compact, non-singular and the components of $Y = \overline{\partial A}^Z \cup \overline{\partial B}^Z$ be non-singular normal crossings. We know from Theorem 2.1 that separation of A and B is possible if and only if it is so in all finite geometric spaces of orderings of $\text{Spec}_r K$ of chain length ≤ 4 . Thus, we may produce (and in fact it is a good exercise to do it) a complete list of all possible trees of spaces with chain length ≤ 4 and stability ≤ 3 , and check in every one the possible configurations of A and B which cannot be separated. Rather than doing it here (which might be very tedious) we will use the geometric criterion to find all *minimal* geometric spaces of orderings X and the configurations of A and B in them which are not separable. In particular note that X being minimal we are restricted to extensions.

Recall that by the ultrafilter theorem, cf. [Brö3], orderings coincide with ultrafilters of open semialgebraic sets, so that, as it is becoming customary, we will depict the orderings as small parallelepipeds in M (we use cubes in the three space). This way $\sigma \in A$ means that A contains the parallelepiped corresponding to σ . Moreover, to keep a graphic image in mind, we will assign the white color to the set A and the black to B , and our discussion will always be up to reversing colors, that is, reversing the roles of A and B . Also we will look for the “essentially different” configurations in the following sense: given a non-separable configuration, in a space X , its image by any automorphism of X produces another one which is also non-separable and which will be considered equivalent to the previous one, so that our description will be *up to isomorphism*. However we will not enter into the precise description of all isomorphisms of X . Let us just say that since we will be dealing with extensions $X = X'[\mathbb{Z}_2]$, where X' is a geometric space defined in a wall W , we will consider the automorphism group $\text{Aut}(X') \times \text{Aut}(\mathbb{Z}_2)$, that is, either automorphisms of X' or compositions of them with the automorphism of X consisting in turning it up-side down, which geometrically corresponds to take the “symmetry” with respect to W .

We start by recalling that in the two-dimensional case, Theorem 2.1 just says that A and B are separable if and only they are so in any finite geometric subspace of orderings of chain length ≤ 2 . Since spaces of orderings of chain length 2 are fans and the stability index is ≤ 2 , we have that A and B are separable if and only if they are so in any

geometric 4-element fan of the surface. Now, if the components of the border of $A \cup B$ are normal crossings, these fans can be taken centered at a curve, and will be depicted as in Figure 3.1 (in fact the height of the rectangles should be infinitesimal with respect to the width, but that is irrelevant in our context).

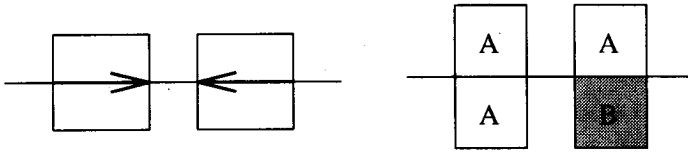

Fig. 3.1

Fig. 3.2

Thus, the only configuration for disjoint A and B so that they cannot be separated consists of three of the elements being in A (white) and the fourth in B (black) or viceversa, so that, up to isomorphism and reversing colors, we get the pattern of Figure 3.2 above. Note in this case the automorphism group of F is the Klein group generated by the two symmetries with respect to the x and y axis, which move the black square to any position.

Let us turn to the 3-dimensional case. Take A and B as in the statement of Theorem 2.4, and assume that they are not separable. Applying Theorem 2.4, this means that there is a wall W in which neither the shadows A' and B' nor the counter-shadows A'' and B'' can be separated. We will distinguish several cases, but before entering into their discussion we need to introduce one more convention. Consider the wall W (represented by a plane) and fix a generator g for $\mathcal{I}(W)$, so that we may talk (at least in a Zariski open subset of M) of the positive half-space and the negative half-space defined by W (where the equation is positive and negative respectively). We will also depict in white the sets A' and A'' , and in black the sets B' and B'' . The spaces we are to construct are extensions of subspaces of $\text{Spec}_r K(W)$, so that all configurations will consist of cubes (white and black) with one face on W .

We know from 2.3 that given a non-separable configuration for A and B , the sets A_g and B_g give another non-separable configuration. Now, A_g and B_g are produced by reversing colors in the negative halfspace of

W , that is, turning the white cubes in the negative halfspace of W into black, and the black cubes in the negative halfspace of W into white. We will denote this operation of reversing colors in the negative halfspace as *chess-coloring*. Thus, we say that two configurations are *equivalent* if one can be obtained from the other by a sequence of automorphisms and chess-coloring, and we will determine all minimal configurations which obstruct separation *up to equivalence*.

Now, consider in W a pattern like the one shown in figure 3.2 corresponding to a fan F centered at curve γ with three white and one black element which cannot be separated and which represents the shadows A' and B' . Thus, a minimal configuration of A and B producing these shadows is obtained by considering 4 elements (cubes) in the extension $F[\mathbb{Z}_2]$, three white (i.e. in A) and one black (i.e. in B) projecting onto A' and B' , respectively. Moreover, each of these cubes can be in any of its two possible positions. We will call any of these configurations a *shadows-cube*. Thus, we have a total of 16 possible configurations for the shadows-cube. Since for each of them also its symmetric with respect to W belongs to the family, they reduce to 8 up to isomorphism. The following picture depicts four of them which will be of special relevance later. The other four appear in Figures 3.6 and 3.7 below:

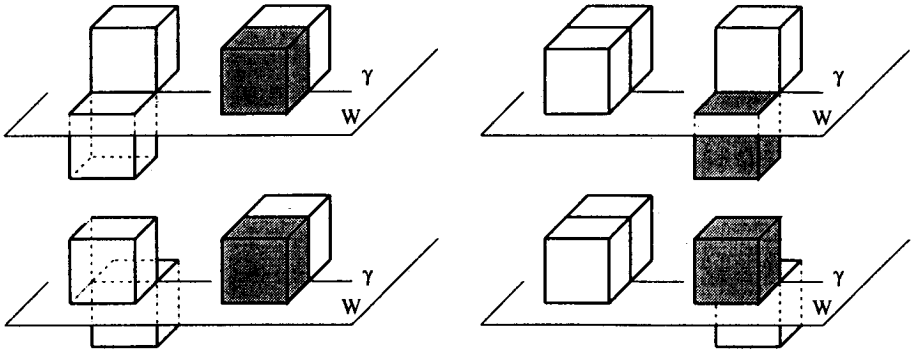

Fig. 3.3

Consider now the chess-colored configuration of a shadows-cube. Notice that it produces as counter-shadows in W the shadows of the original one, where now the white squares stand for A'' and the black one for B'' . This way we get the 16 possible configurations (8 after equivalence) for the *counter-shadows-cube* over the given 3 white, 1 black pattern on

the fan F as counter-shadows. Picture 3.4 below represents the chess-colored configurations of the ones of Figure 3.3.

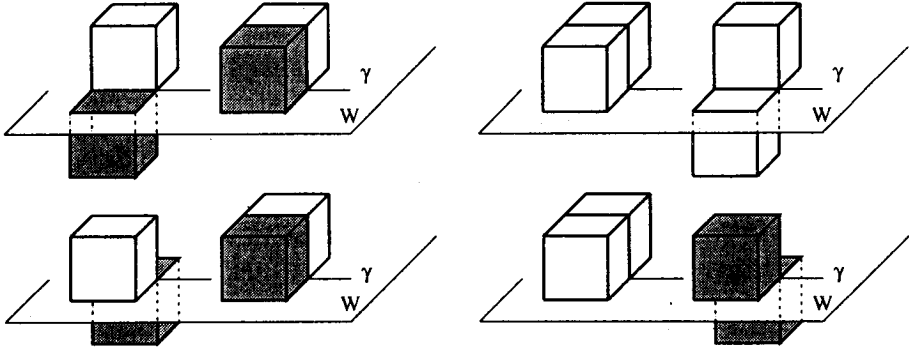

Fig. 3.4

Note that, differently to what happens in the shadows-cubes, where we always have three elements in A and only one in B , in the counter-shadows-cubes we may have any number of elements (from zero to four) in A and B . Our job will basically consist in combining these “elementary” shadows and counter-shadows-cubes.

We are now ready for the discussion of the 3-dimensional case. Recall that we have a wall W in which neither the shadows A' and B' nor the counter-shadows A'' and B'' can be separated. We distinguish several cases.

Case 3.1 $A' \cap B' \neq \emptyset, A'' \cap B'' \neq \emptyset$.

Take $\sigma' \in A' \cap B'$ and $\sigma'' \in A'' \cap B''$. Since $A \cap B = \emptyset$, we get that $\sigma' \neq \sigma''$ and we have a configuration of the type

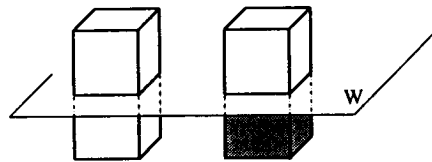

Fig. 3.5

where the pair of adjacent white cubes lie over σ'' and the white and black pair lie over σ' . This corresponds to a 4-element fan of M centered

at W . As was pointed out before, its automorphism group is the Klein group generated by the symmetry with respect to W and the one which interchanges de roles of σ' and σ'' and therefore this configuration is unique up to equivalence.

Case 3.2 $A' \cap B' = \emptyset$, $A'' \cap B'' \neq \emptyset$.

Since the boundaries of A' and B' are normal crossing, there is a geometric 4-element fan F in W , centered at a curve γ , in which A' and B' cannot be separated. Assume that on W we have a configuration for A' and B' as in Figure 3.2. Then γ must be in the intersection of W with another wall T of A and B which we depict as an orthogonal surface to W . Then one of the 8 (up to isomorphism) configurations of the shadows-cube must be contained in $A \cup B$. Let us take a closer look at some of them.

Note that when the two pairs of adjacent cubes are in the same side of W , cf. Figure 3.6 below, they produce a 4-element fan of M as the one already considered in Case 3.1, see Figure 3.5, but this time centered at the vertical wall T .

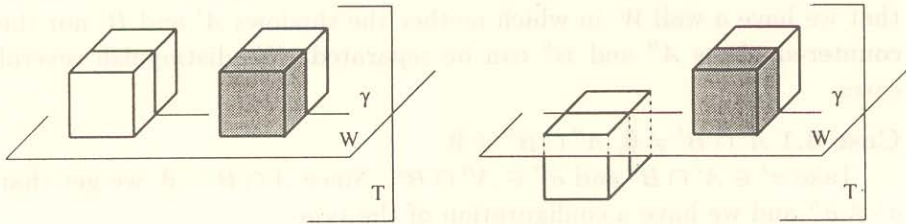

Fig. 3.6

Therefore we discard these two cases, which reduces to 6 the number of non-isomorphic configurations to be considered. Next, when the pairs of adjacent cubes are “symmetrically” displayed with respect to the curve γ , cf. Figure 3.7 below, they also build a geometric 4-element fan of M (this time centered at γ) in which separation is not possible, so that no further work is needed. In fact, notice that in this case taking the counter-shadows we get also that, in the fan F on W , A'' and B'' are not separable and $A'' \cap B'' = \emptyset$. Thus, we are in the situation (3.4.1)

below and we also discard these configurations here.

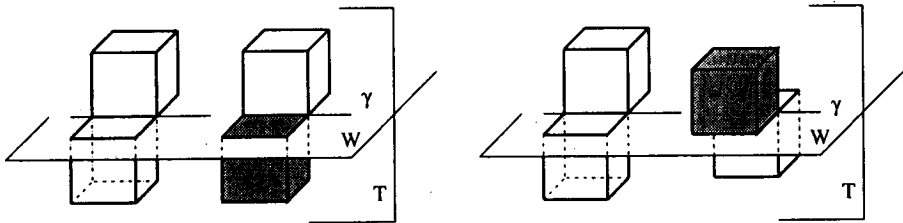

Fig. 3.7

Altogether (always up to isomorphism) we are reduced to consider the 4 possible configurations for the shadows-cube shown in Figure 3.3 above. Now take a geometric ordering $\sigma'' \in A'' \cap B''$ such that $\sigma'' \notin F$, which is always possible since $A'' \cap B''$ is an open set: just take any ordering centered at a point not in the curve γ . Since $\sigma'' \in A'' \cap B''$, its two generalizations in $\text{Spec}_r K$ are both in A or both in B . Now, the minimum geometric space of orderings of W which contains $\{\sigma''\}$ and F is the sum $\{\sigma''\} + F$, and we may combine independently the patterns over each summand in the extension $X = (\{\sigma''\} + F)[\mathbb{Z}_2]$ whose structural tree is shown in Figure 3.12 a) below. Moreover, the automorphism group of X is generated by the one of F and the up-side down symmetry on X , so that we get 8 possible non-separable minimal configurations obtained by combining each of the 4 configurations of Figure 3.3-with a pair of white or black boxes over σ'' . The figure 3.8 below just shows these combinations for the first pattern of Figure 3.3.

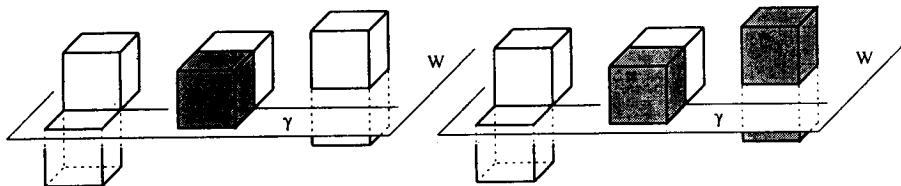

Fig. 3.8

Case 3.3 $A' \cap B' \neq \emptyset, A'' \cap B'' = \emptyset$.

This case is precisely the chess-colored version of the previous one. Thus, we get the 8 chess-colored configurations of the ones in Case 3.2.

Case 3.4 $A' \cap B' = \emptyset, A'' \cap B'' = \emptyset$.

Note that in particular this implies that over any ordering $\sigma' \in \text{Spec}_r K(W)$ there is at most one generalization in $A \cup B$. Now, as above, there are geometric 4-element fans F_1 and F_2 in W such that A' and B' cannot be separated in F_1 and A'' and B'' cannot be separated in F_2 . Let γ_i be the curve at which F_i is centered. We have to deal simultaneously with a shadows-cube (which produces the shadows A' and B' on F_1) and one of its chess-colored configurations (which produces the counter-shadows A'' and B'' on F_2). We distinguish several subcases:

(3.4.1) $F_1 = F_2 = F$

Here we get one of the configurations described in Figure 3.7 in which the adjacent blocks of the shadows-cube over F are symmetrically displayed with respect to γ . Notice that strictly speaking these configurations are not equivalent since they lie in different geometric 4-element fans so that they cannot be automorphic images of each other. However there is an isomorphism between both fans taking one to the other. Note also that these fans are centered at the curve γ instead of at the wall W , and therefore are not extensions of a space centered at W . If we want them to be centered at a wall we must blow-up M , retrieving the patterns of Figure 3.6. Alternatively we may see them as subfans of the 8-element fan $F[\mathbb{Z}_2]$, centered at W .

(3.4.2) $F_1 \neq F_2$ but $F_1 \cap F_2 \neq \emptyset$.

Then $\gamma_1 = \gamma_2$ and $F_1 \cap F_2$ is a trivial fan with 2-elements so that in W we have, for instance, patterns like

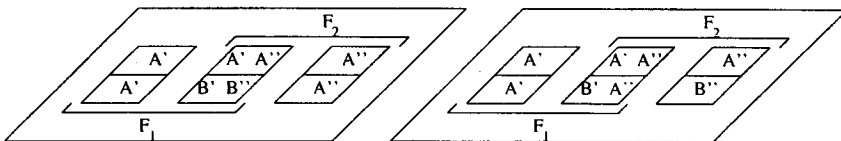

Fig. 3.9

Since any ordering $\sigma' \in \text{Spec}_r K(W)$ has at most one generalization in $A \cup B$, this forces the configurations over F_1 and F_2 to share their building block over $F_1 \cap F_2$. The pictures below give an example over each one of the patterns of Figure 3.9. The four cubes on the left stand for the shadows-cube while the four on the right are the counter-shadows one.

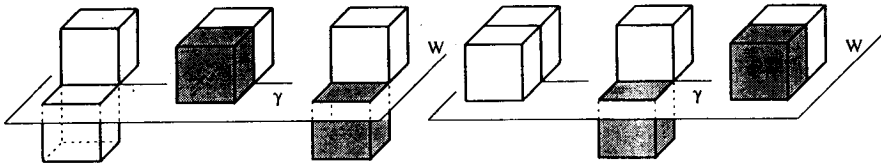

Fig. 3.10

A direct and easy inspection shows that we always get a configuration which actually includes either a 4-element fan centered at the wall T (cf. Figure 3.5 above) or a symmetric configuration along γ as the one considered in (3.4.1). Therefore this case does not produce any new minimal configuration.

(3.4.3) $F_1 \cap F_2 = \emptyset$ but $F_1 \cup F_2 \neq F_1 + F_2$.

This means that the orderings of F_1 and F_2 are not independent, which implies that $\gamma_1 = \gamma_2$. Thus in W we have a pattern of the type:

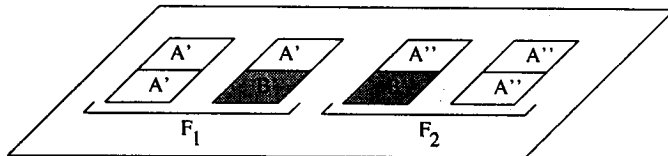

Fig. 3.11

An easy computation shows again that this case is redundant, since, for instance, we can replace one of the F_i 's so that we are in the case just treated in (3.4.2).

(3.4.4) $F_1 \cap F_2 = \emptyset$ and $F_1 \cup F_2 = F_1 + F_2$.

In particular this implies that γ_1 and γ_2 are different and the configurations over F_1 and F_2 can be combined independently. Thus, we are in the space $X = (F_1 + F_2)[\mathbb{Z}_2]$ with structural tree as in Figure 3.12 b)

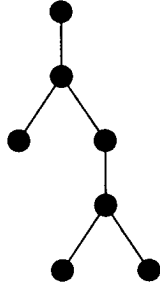

Fig. 3.12a)

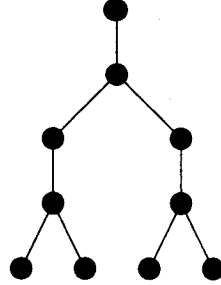

Fig. 3.12b)

and whose automorphism group is generated by the ones of F_1 , F_2 , the up-side down symmetry and the “symmetry” which interchanges F_1 and F_2 (the symmetry along the axis of the tree). Thus, up to equivalence we get the 16 configurations obtained by combining the 4 patterns of the shadows-cubes with their 4 chess-colored ones. The following picture just shows some examples of them. Moreover, note that if we chess-color one of these 16 configurations, we get another one of the family, up to change the roles of F_1 and F_2 . Thus, up to equivalence we only get 8 different configurations in X .

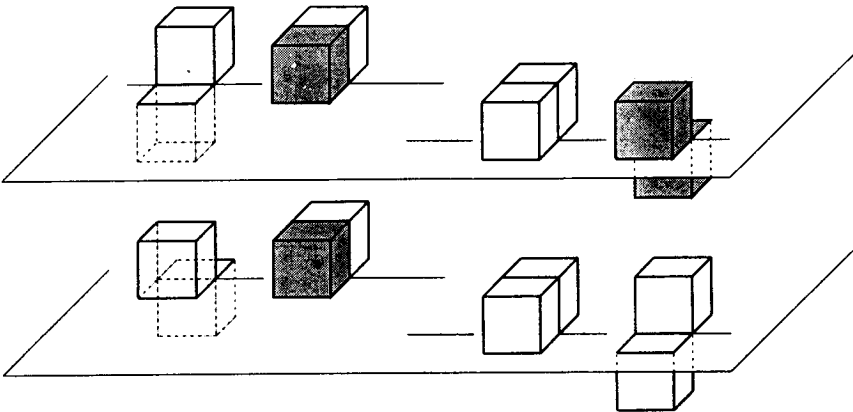

Fig. 3.13

Altogether we get 19 essential configurations, which we summarize in the following

Proposition 3.5. *Up to equivalence and reversing the roles of A and B , A and B cannot be separated if and only for some wall W they contain one the following configurations in the corresponding GSO:*

- i) the one of Case 3.1 (Fig. 3.5); here the GSO is the 4-element fan $2E[\mathbb{Z}_2]$.*
- ii) the 8 of Case 3.2 (Fig. 3.8); here the GSO is $(F + E)[\mathbb{Z}_2] = (2E[\mathbb{Z}_2] + E)[\mathbb{Z}_2]$.*
- iii) the two of Case 3.4.1 (Fig. 3.7); here the GSOs are 4-element fans $2E[\mathbb{Z}_2]$.*
- iv) the 8 of Case 3.4.4 (fig. 3.13); here the GSO is $(F_1 + F_2)[\mathbb{Z}_2] = (2E[\mathbb{Z}_2] + 2E[\mathbb{Z}_2])[\mathbb{Z}_2]$.*

Remark 3.6. *a) Note that in Case 3.2, sometimes it might be possible to take $\sigma'' \in F$, getting a space X with smaller cardinal in which the separation is not possible. In this situation $X = F[\mathbb{Z}_2]$, the fan of 8-elements, and we get apparently different patterns, as the ones shown in Figure 3.14. However, this case produces a 4-element fan centered at the vertical wall T and therefore is not minimal.*

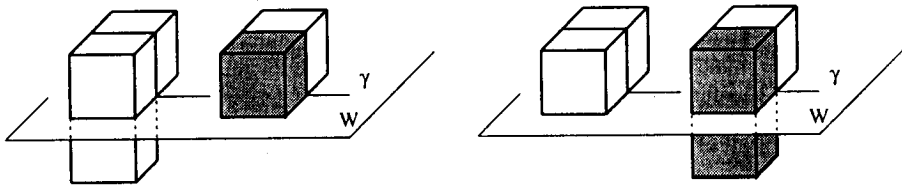

Fig. 3.14

b) Also note that in Case 3.2, if we do not take σ'' independent from F (for instance we take σ'' specializing to the same curve γ), then the minimal subspace containing F and σ'' is not their union, but has a sixth element: the "symmetric" order to σ'' with respect to γ . The space spanned by F and σ'' is the union of two non-disjoint 4-element fans of

W which has structural tree $3E[\mathbb{Z}_2]$. Geometrically this corresponds to place the pair of cubes in A or B over σ'' attached also to the curve γ , getting the different versions of Bröcker's example of basic semialgebraic sets in a 3-dimensional space which cannot be separated, see [Brö2]. Again, this space is not minimal, since it is always possible to take $\sigma'' \in A'' \cap B''$ which does not specialize to the curve γ . Thus this situation is already included in the ones considered above.

References

- [AcAnBg] F. Acquistapace, C. Andradas, F. Broglia, *Separation of semi-algebraic sets*, to appear.
- [AcBgFo] F. Acquistapace, F. Broglia, E. Fortuna, *A separation theorem in dimension 3*, to appear in Nagoya Mathematical Journal **143** (1996).
- [AcBgVe] F. Acquistapace, F. Broglia, P. Velez, *An algorithmic criterion for basicness in dimension 2*, Manuscripta Math. **85** (1994), 45-66.
- [AnBröRz] C. Andradas, L. Bröcker, J.M. Ruiz, *Constructible sets in Real Geometry*, to appear.
- [AnRz] C. Andradas, J.M. Ruiz, *More on basic semialgebraic sets*, in Real Algebraic and Analytic Geometry (1992), Lectures Notes in Math. 1524. Springer Verlag 128-139.
- [BiMi] E. Bierstone, P. Milman, *Canonical desingularization in characteristic zero: an elementary proof*, to appear.
- [BoCoRy] J. Bocknak, M. Coste, M.F. Roy, *Geometrie algebrique reelle* (1987), Springer Verlag, Berlin-Heidelberg-New York.
- [Brö1] L. Bröcker, *Spaces of orderings and semi-algebraic sets*, Quadratic and hermitian forms CMS Conf. Proc. Providence: Amer. Math. Soc., vol 4, 1984, pp. 231-248.
- [Brö2] L. Bröcker, *On the separation of basic semialgebraic sets by polynomials*, Manuscripta Math. **60** (1988), 497-508.

- [Brö3] L. Bröcker, *On basic semialgebraic sets*, Exp. Math. **9** (1991), 289-334.
- [Ma] M. Marshall, *The Witt ring of a space of orderings*, Trans. Am. Math. Soc. **258** (1980), 505-521.
- [Sch] C. Scheiderer, *Stability index on real varieties*, Invent. Math. **97** (1989), 467-483.
- [Ve] M.P. Velez, *La geometría de los abanicos en dimension 2*, Ph.D. Thesis. Madrid 1995.

F. Acquistapace, F. Broglia,
Dipartimento di Matematica,
Università di Pisa,
Via F. Buonarroti 2, 56127 Pisa, Italy.
acquistf@dm.unipi.it,
broglia@dm.unipi.it

C. Andradas,
Departamento de Algebra,
Universidad Complutense,
andradas@sun11.mat.ucm.es